

				nr.rys
				1
	długość mm	końcówka A	końcówka B	
C80002ABE	434	F 10X1	ø10	
C80005ABE	530	F 10X1	ø10	
C80006ABE	390	F 10X1	ø10	
C80013ABE	410	F 10X1	ø10	
C80017ABE	478	F 10X1	ø10	
C80018ABE	345	F 10X1	ø10	
C80020ABE	280	F 10X1,25	ø10	
C80023ABE	495	F 10X1,25	ø10	
C80026ABE	454	F 10X1,25	ø10	
C80029ABE	280	F 10X1,25	ø10	
C80450ABE	285	F 10X1,25	ø10	
C80454ABE	365	F 10X1,25	ø10	
C80455ABE	400	F 10X1,25	ø10	
C81006ABE	285	F 10X1	ø10	
C81007ABE	252	F 10X1,25	ø10	
C81062ABE	285	F 10X1,25	ø10	
C81009ABE	304	F 10X1	ø10	
C81056ABE	270	F 10X1,25	ø10	
C81450ABE	270	F 10X1,25	ø10	
C81451ABE	283	F 10X1,25	ø10	
C81452ABE	300	F 10X1,25	ø10	
C81453ABE	403	F 10X1,25	ø10	
C81945ABE	495	F 10X1,25	ø10	
C81950ABE	340	F 12X1,25	ø12	
C82105ABE	370	F 10X1	ø12,5	
C88120ABE	435	F 10X1	ø10	
C88152ABE	250	F 10X1,25	ø10	
C88155ABE	320	F 10X1,25	ø10	
C88156ABE	285	F 10X1	ø10	
C88157ABE	300	F 10X1,25	ø10	
C88158ABE	375	F 10X1,25	ø10	
C88159ABE	300	F 10X1,25	ø10	
C88160ABE	420	F 10X1,25	ø10	
C88174ABE	375	F 10X1,25	ø10	
C88175ABE	410	F 10X1	ø10	
C88176ABE	460	F 10X1	ø10	
C88177ABE	505	F 10X1,25	ø10	
C88178ABE	465	F 10X1,25	ø10	
C88210ABE	290	F 10X1	ø10	
				2
	długość mm	końcówka A	końcówka B	
C80214ABE	425	F 10X1	M 10X1	
C80216ABE	285	F 10X1	M 10X1	
C80203ABE	340	F 10X1	M 10X1	
C80217ABE	560	F 10X1	M 10X1	
C80218ABE	495	F 10X1	M 10X1	
C80723ABE	280	F 10X1	M 10X1	

C80725ABE	280	F 10X1	M 10X1
C88164ABE	340	F 10X1	M 10X1
C80021ABE	340	F 10X1,25	M 10X1,25
C80201ABE	225	F 10X1	M 10X1
C80207ABE	300	F 10X1	M 10X1
C80470ABE	415	F 10X1	M 10X1
C80480ABE	375	F 10X1	M 10X1
C80481ABE	230	F 10X1	M 10X1
C80482ABE	355	F 10X1	M 10X1
C80703ABE	313	F 10X1	M 10X1
C80704ABE	486	F 10X1	M 10X1
C80705ABE	408	F 10X1	M 10X1
C80706ABE	320	F 10X1	M 10X1
C80707ABE	315	F 10X1	M 10X1
C80708ABE	365	F 10X1	M 10X1
C80709ABE	363	F 10X1	M 10X1
C80710ABE	485	F 10X1	M 10X1
C80712ABE	297	F 10X1	M 10X1
C80713ABE	385	F 10X1	M 10X1
C80716ABE	250	F 10X1	M 10X1
C80717ABE	340	F 10X1	M 10X1
C81005ABE	185	F 10X1	M 10X1
C81010ABE	310	F 10X1	M 10X1
C81018ABE	365	F 10X1	M 10X1
C81101ABE	340	F 10X1	M 10X1
C81104ABE	335	F 10X1	M 10X1
C81114ABE	290	F 10X1	M 10X1lewy
C81119ABE	390	F 10X1	M 10X1
C81142ABE	360	F 10X1	M 10X1
C81143ABE	268	F 10X1	M 10X1
C81144ABE	355	F 10X1	M 10X1
C81146ABE	405	F 10X1	M 10X1
C81147ABE	290	F 10X1	M 10X1
C81148ABE	307	F 10X1	M 10X1
C81151ABE	355	F 10X1	M 10X1
C81152ABE	294	F 10X1	M 10X1
C81209ABE	242	F 10X1	M 10X1
C81213ABE	185	F 10X1	M 10X1
C81215ABE	233	F 10X1	M 10X1
C82031ABE	360	F 10X1	M 10X1
C82103ABE	370	F 10X1	M 10X1
C82111ABE	390	F 10X1	M 10X1
C82202ABE	310	F 10X1	M 10X1
C82204ABE	450	F 10X1	M 10X1
C82209ABE	505	F 10X1	M 10X1
C82210ABE	485	F 12X1	M 12X1
C83143ABE	485	F 10X1	M 10X1
C82138ABE	485	F 10X1	M 10X1

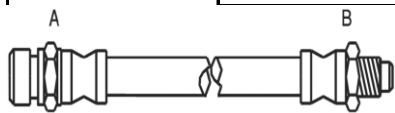

ABE	długość mm	końcówka A	końcówka B
C80003ABE	365	F 10X1	M 10X1

C80022ABE	295	F 10X1,25	M 10X1,25
C80025ABE	265	F 12X1,25	M 12X1,25
C80027ABE	275	F 10X1,25	M 10X1,25
C80031ABE	210	F 10X1	M 10X1
C80032ABE	225	F 10X1	M 10X1
C80034ABE	275	F 10X1	M 10X1
C80035ABE	262	F 10X1	M 10X1
C80038ABE	226	F 10X1	M 10X1
C80041ABE	190	F 10X1	M 10X1
C80047ABE	170	F 10X1	M 10X1
C80048ABE	310	F 10X1	M 10X1
C80052ABE	350	F 10X1	M 10X1
C80053ABE	423	F 10X1	M 10X1
C80309ABE	174	F 10X1	M 10X1
C80452ABE	470	F 10X1	M 10X1
C80456ABE	430	F 10X1	M 10X1
C80457ABE	320	F 10X1,25	M 10X1,25
C80458ABE	325	F 10X1	M 10X1
C80459ABE	170	F 10X1,25	M 3/8 24
C80460ABE	315	F 10X1	M 10X1
C80461ABE	275	F 12X1,25	M 12X1.25
C80462ABE	285	F 10X1	M 10X1
C80463ABE	430	F 10X1	M 10X1
C80464ABE	540	F 10X1	M 10X1
C80517ABE	310	F 10X1	M 10X1
C81011ABE	450	F 10X1	M 10X1
C81017ABE	400	F 10X1	M 10X1
C81020ABE	435	F 10X1	M 10X1
C81029ABE	575	F 10X1	M 10X1
C81030ABE	185	F 10X1	M 10X1
C81031ABE	600	F 10X1	M 10X1
C81032ABE	450	F 10X1	M 10X1
C81033ABE	410	F 10X1	M 10X1
C81034ABE	440	F 10X1	M 10X1
C81050ABE	426	F 10X1	M 10X1
C81051ABE	282	F 12X1	M 12X1
C81057ABE	285	F 10X1	M 10X1
C81058ABE	353	F 10X1	M 10X1
C81059ABE	459	F 10X1	M 10X1
C81061ABE	436	F 10X1	M 10X1
C81080ABE	195	F 10X1	M 10X1
C81090ABE	435	F 10X1	M 10X1
C81135ABE	390	F 10X1	M 10X1
C81161ABE	290	F 10X1	M 10X1
C81163ABE	365	F 10X1	M 10X1
C81164ABE	250	F 10X1	M 10X1
C81300ABE	445	F 10X1	M 10X1
C81301ABE	462	F 10X1	M 10X1
C81304ABE	280	F 10X1	M 10X1
C81305ABE	375	F 10X1	M 10X1
C81454ABE	167	F 10X1,25	M 3/8 24
C81455ABE	280	F 10X1,25	M 12X1,25
C81559ABE	380	F 10X1	M 10X1

C81590ABE	490	F 10X1	M 10X1
C81605ABE	353	F 10X1	M 10X1
C81607ABE	560	F 10X1	M 10X1
C81608ABE	190	F 10X1	M 10X1
C82016ABE	375	F 10X1,25	M 10X1,25
C82017ABE	500	F 10X1	M 10X1
C82023ABE	325	F 10X1	M 10X1
C82024ABE	344	F 10X1,25	M 10X1,25
C82026ABE	370	F 10X1,25	M 10X1,25
C82034ABE	500	F 10X1	M 10X1
C82108ABE	580	F 12X1	M 12X1
C82113ABE	395	F 10X1	M 10X1
C82114ABE	420	F 10X1	M 10X1
C82116ABE	371	F 10X1	M 10X1
C82120ABE	371	F 10X1	M 10X1
C82123ABE	235	F 12X1	M 12X1
C82126ABE	420	F 12X1	M 12X1
C82127ABE	355	F 12X1	M 12X1
C82128ABE	320	F 12X1	M 12X1
C82129ABE	320	F 12X1	M 12X1
C82134ABE	532	F 12X1	M 10X1
C82215ABE	563	F 10X1	M 10X1
C82217ABE	310	F 10X1	M 10X1
C82221ABE	295	F 12X1	M 12X1
C85101ABE	371	F 10X1	M 10X1
C85107ABE	360	F 10X1	M 10X1
C85117ABE	485	F 10X1	M 10X1
C85119ABE	570	F 10X1	M 10X1
C85123ABE	435	F 10X1	M 10X1
C85130ABE	402	F 10X1	M 10X1
C85131ABE	335	F 10X1	M 10X1
C85132ABE	385	F 10X1	M 10X1
C85144ABE	490	F 10X1	M 10X1
C85145ABE	370	F 10X1	M 10X1
C85146ABE	370	F 10X1	M 10X1
C85206ABE	260	F 10X1	M 10X1
C85218ABE	460	F 10X1	M 10X1
C85220ABE	285	F 10X1	M 10X1
C85221ABE	310	F 10X1	M 10X1
C86104ABE	370	F 10X1	M 10X1
C86105ABE	355	F 10X1	M 10X1
C86112ABE	355	F 10X1	M 10X1
C86113ABE	375	F 10X1	M 10X1
C86115ABE	460	F 10X1	M 10X1
C86117ABE	457	F 10X1	M 10X1
C86136ABE	460	F 10X1,25	M 10X1
C86140ABE	470	F 8X1,25	M 10X1
C86144ABE	200	F 10X1	M 10X1
C86149ABE	490	F 10X1	M 10X1
C86151ABE	340	F 10X1	M 10X1
C86202ABE	330	F 10X1	M 10X1
C86216ABE	310	F 10X1	M 10X1
C86218ABE	345	F 10X1	M 10X1

C87104ABE	370	F 10X1	M 10X1
C87104ABE	370	F 10X1	M 10X1
C87105ABE	410	F 10X1	M 10X1
C87110ABE	505	F 10X1	M 10X1
C87123ABE	290	F 10X1	M 10X1
C87127ABE	406	F 10X1	M 10X1
C87157ABE	504	F 10X1	M 10X1
C87163ABE	530	F 10X1	M 10X1
C87167ABE	326	F 10X1	M 10X1
C87191ABE	155	F 10X1	M 10X1
C87192ABE	433	F 10X1	M 10X1
C87222ABE	290	F 10X1	M 10X1
C87228ABE	290	F 10X1	M 10X1
C87229ABE	375	F 10X1	M 10X1
C87258ABE	340	F 10X1	M 10X1
C87265ABE	285	F 10X1	M 10X1
C88101ABE	440	F 10X1	M 10X1
C88102ABE	435	F 10X1	M 10X1
C88103ABE	405	F 10X1	M 10X1
C88104ABE	385	F 10X1	M 10X1
C88105ABE	410	F 10X1	M 10X1
C88106ABE	460	F 10X1	M 10X1
C88107ABE	465	F 10X1	M 10X1
C88115ABE	584	F 10X1	M 10X1
C88116ABE	490	F 10X1	M 10X1
C88117ABE	408	F 10X1	M 10X1
C88119ABE	390	F 10X1	M 10X1
C88122ABE	435	F 10X1	M 10X1
C88124ABE	415	F 10X1	M 10X1
C88126ABE	504	F 10X1	M 10X1
C88127ABE	400	F 10X1	M 10X1
C88129ABE	435	F 10X1	M 10X1
C88130ABE	420	F 10X1	M 10X1
C88132ABE	490	F 10X1	M 10X1
C88134ABE	515	F 10X1	M 10X1
C88137ABE	472	F 10X1	M 10X1
C88139ABE	465	F 10X1	M 10X1
C88140ABE	493	F 10X1	M 10X1
C88146ABE	420	F 10X1	M 10X1
C88147ABE	435	F 10X1	M 10X1
C88149ABE	185	F 10X1	M 10X1
C88151ABE	385	F 10X1,25	M 10X1,25
C88161ABE	252	F 10X1,25	M 12X1,25
C88162ABE	305	F 10X1,25	M 10X1,25
C88163ABE	346	F 10X1,25	M 10X1,25
C88164ABE	340	F 10X1	M 10X1
C88165ABE	310	F 10X1	M 10X1
C88166ABE	435	F 10X1	M 3/8 24
C88179ABE	437	F 10X1	M 10X1
C88180ABE	460	F 10X1	M 10X1
C88181ABE	410	F 10X1	M 10X1
C88183ABE	385	F 10X1	M 10X1
C88184ABE	410	F 10X1	M 10X1

C88185ABE	515	F 10X1	M 10X1
C88186ABE	486	F 10X1	M 10X1
C88187ABE	385	F 10X1	M 10X1
C88188ABE	560	F 10X1	M 10X1
C88189ABE	435	F 10X1	M 10X1
C88190ABE	400	F 10X1	M 10X1
C88191ABE	400	F 10X1	M 10X1
C88193ABE	400	F 10X1	M 10X1
C88194ABE	400	F 10X1	M 10X1
C88195ABE	360	F 10X1	M 10X1
C88199ABE	584	F 10X1	M 10X1
C88212ABE	157	F 10X1	M 10X1
C88221ABE	210	F 10X1	M 10X1
C88223ABE	360	F 10X1	M 10X1
C88228ABE	411	F 10X1	M 10X1
C88245ABE	485	F 10X1	M 10X1
C88247ABE	490	F 10X1	M 10X1
C88248ABE	186	F 10X1	M 10X1
C88249ABE	510	F 10X1	M 10X1
C88250ABE	230	F 10X1	M 10X1
C88270ABE	423	F 10X1	M 10X1
C88271ABE	383	F 10X1	M 10X1
C88282ABE	185	F 10X1	M 10X1
C88285ABE	210	F 10X1	M 10X1
C88296ABE	330	F 10X1	M 10X1
C88298ABE	490	F 10X1	M 10X1

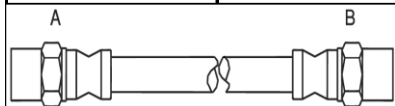

ABE	długość mm	końcówka A	końcówka B
C80008ABE	168	F 10X1	F 10X1
C80024ABE	260	F 10X1,25	F 10X1,25
C80202ABE	310	F 10X1	F 10X1
C80204ABE	240	F 10X1	F 10X1
C80471ABE	220	F 10X1	F 10X1
C80701ABE	265	F 10X1	F 10X1
C80714ABE	310	F 10X1	F 10X1
C80715ABE	224	F 10X1	F 10X1
C81003ABE	168	F 10X1	F 10X1
C81004ABE	185	F 10X1	F 10X1
C81070ABE	344	F 10X1	F 10X1
C81070ABE	336	F 10X1	F 10X1
C81103ABE	360	F 10X1	F 10X1
C81105ABE	405	F 10X1	F 10X1
C81124ABE	465	F 10X1	F 10X1
C81127ABE	425	F 10X1	F 10X1
C81128ABE	327	F 10X1	F 10X1
C81128ABE	320	F 10X1	F 10X1
C81131ABE	465	F 10X1	F 10X1
C81141ABE	295	F 10X1	F 10X1
C81149ABE	385	F 10X1	F 10X1
C81153ABE	202	F 10X1	F 10X1
C81207ABE	195	F 10X1	F 10X1

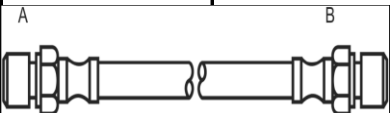
C81208ABE	265	F 10X1	F 10X1
C81212ABE	225	F 10X1	F 10X1
C81216ABE	175	F 10X1	F 10X1
C82107ABE	494	F 10X1	F 10X1
C82125ABE	305	F 10X1	F 10X1
C83146ABE	445	F 10X1	F 10X1
			
ABE	długość mm	końcówka A	końcówka B
C80001ABE	415	F 10X1	F 10X1
C80004ABE	255	F 10X1	F 10X1
C80009ABE	195	F 10X1	F 10X1
C80012ABE	380	F 10X1	F 10X1
C80028ABE	257	F 10X1,25	F 10X1,25
C80033ABE	270	F 10X1	F 10X1
C80040ABE	330	F 10X1	F 10X1
C80055ABE	182	F 10X1	F 10X1
C80056ABE	210	F 10X1	F 10X1
C80304ABE	200	F 10X1	F 10X1
C80306ABE	300	F 10X1	F 10X1
C80307ABE	263	F 10X1	F 10X1
C80308ABE	170	F 10X1	F 10X1
C80451ABE	240	F 10X1,25	F 10X1,25
C80453ABE	295	F 10X1	F 10X1
C80825ABE	283	F 10X1	F 10X1
C80826ABE	318	F 10X1	F 10X1
C80833ABE	250	F 10X1	F 10X1
C80837ABE	385	F 10X1	F 10X1
C81013ABE	280	F 10X1	F 10X1
C81040ABE	380	F 10X1	F 10X1
C81106ABE	340	F 10X1	F 10X1
C81162ABE	323	F 10X1	F 10X1
C81210ABE	160	F 10X1	F 10X1
C81226ABE	170	F 10X1	F 10X1
C81234ABE	275	F 10X1	F 10X1
C81239ABE	425	F 10X1	F 10X1
C81302ABE	335	F 10X1	F 10X1
C81303ABE	335	F 10X1	F 10X1
C81306ABE	212	F 10X1	F 10X1
C81308ABE	409	F 10X1	F 10X1
C81309ABE	272	F 10X1	F 10X1
C81331ABE	210	F 10X1	F 10X1
C81507ABE	260	F 10X1	F 10X1
C81522ABE	280	F 10X1	F 10X1
C81557ABE	370	F 10X1	F 10X1
C81558ABE	240	F 10X1	F 10X1
C81561ABE	320	F 10X1	F 10X1
C81592ABE	320	F 10X1	F 10X1
C81610ABE	234	F 10X1	F 10X1
C82004ABE	320	F 10X1	F 10X1
C82012ABE	280	F 10X1	F 10X1
C82013ABE	320	F 10X1	F 10X1

C82025ABE	317	F 10X1,25	F 10X1,25
C82032ABE	295	F 10X1,25	F 10X1,25
C82040ABE	270	F 10X1	F 10X1
C82122ABE	215	F 12X1	F 12X1
C82124ABE	315	F 10X1	F 10X1
C82135ABE	270	F 12X1	F 12X1
C82136ABE	408	F 12X1	F 12X1
C82137ABE	280	F 10X1	F 10X1
C84138ABE	300	F 10X1	F 10X1
C84142ABE	200	F 10X1	F 10X1
C84219ABE	222	F 10X1	F 10X1
C85129ABE	276	F 10X1	F 10X1
C85131ABE	235	F 10X1	F 10X1
C85132ABE	220	F 10X1	F 10X1
C85133ABE	260	F 10X1	F 10X1
C85202ABE	280	F 10X1	F 10X1
C85203ABE	305	F 10X1	F 10X1
C85211ABE	205	F 10X1	F 10X1
C86124ABE	275	F 10X1	F 10X1
C86125ABE	245	F 10X1	F 10X1
C86130ABE	260	F 10X1	F 10X1
C86203ABE	215	F 10X1	F 10X1
C86210ABE	216	F 10X1	F 10X1
C86211ABE	205	F 10X1	F 10X1
C86214ABE	207	F 10X1	F 10X1
C86222ABE	207	F 10X1	F 10X1
C86223ABE	213	F 10X1	F 10X1
C87120ABE	370	F 10X1	F 10X1
C87172ABE	190	F 10X1	F 10X1
C87177ABE	263	F 10X1	F 10X1
C87178ABE	245	F 10X1	F 10X1
C87184ABE	270	F 3/8 24	F 3/8 24
C87219ABE	367	F 10X1	F 10X1
C87224ABE	370	F 10X1	F 10X1
C87242ABE	220	F 3/8 24	F 3/8 24
C87243ABE	210	F 10X1	F 10X1
C87264ABE	220	F 10X1	F 10X1
C88108ABE	245	F 10X1	F 10X1
C88109ABE	245	F 10X1	F 10X1
C88114ABE	328	F 10X1	F 10X1
C88148ABE	170	F 10X1	F 10X1
C88172ABE	245	F 10X1	F 10X1
C88211ABE	215	F 10X1	F 10X1
C88213ABE	220	F 10X1	F 10X1
C88218ABE	195	F 10X1	F 10X1
C88225ABE	201	F 10X1	F 10X1
C88231ABE	243	F 10X1	F 10X1
C88235ABE	260	F 10X1	F 10X1
C88236ABE	250	F 10X1	F 10X1
C88238ABE	305	F 10X1	F 10X1
C88241ABE	271	F 10X1	F 10X1
C88242ABE	400	F 10X1	F 10X1
C88243ABE	250	F 10X1	F 10X1

C88292ABE	243	F 10X1	F 10X1
C88299ABE	190	F 10X1	F 10X1
C89208ABE	270	F 10X1	F 10X1
C89211ABE	275	F 10X1	F 10X1

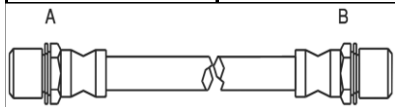

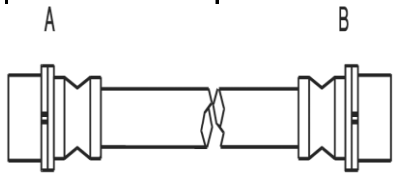

6

ABE	długość mm	końcówka A	końcówka B
C80101ABE	285	F 10X1	F 10X1
C80103ABE	305	F 10X1	F 10X1
C80104ABE	300	F 10X1	F 10X1
C80105ABE	370	F 10X1	F 10X1
C80106ABE	355	F 10X1	F 10X1
C80107ABE	345	F 10X1	F 10X1
C80107ABE	345	F 10X1	F 10X1
C80109ABE	330	F 10X1	F 10X1
C80111ABE	380	F 10X1	F 10X1
C80129ABE	365	F 10X1	F 10X1
C80130ABE	360	F 10X1	F 10X1
C80147ABE	261	F 10X1	F 10X1
C80149ABE	195	F 10X1	F 10X1
C80401ABE	325	F 10X1	F 10X1
C80402ABE	260	F 10X1	F 10X1
C80407ABE	270	F 10X1	F 10X1
C80408ABE	245	F 10X1	F 10X1
C80409ABE	305	F 10X1	F 10X1
C80410ABE	215	F 10X1	F 10X1
C80411ABE	295	F 10X1	F 10X1
C80418ABE	200	F 10X1	F 10X1

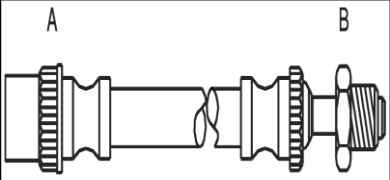
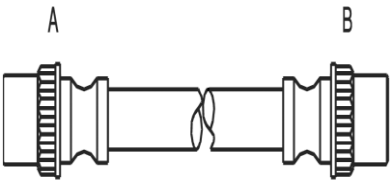

7

ABE	długość mm	końcówka A	końcówka B
C80015ABE	190	F 10X1	F 10X1
C80010ABE	320	F 10X1	F 10X1
C80210ABE	245	F 10X1	F 10X1
C80211ABE	225	F 10X1	F 10X1
C81117ABE	375	F 10X1	F 10X1
C81120ABE	320	F 10X1	F 10X1
C81123ABE	355	F 10X1	F 10X1
C81129ABE	310	F 10X1	F 10X1
C81130ABE	285	F 10X1	F 10X1
C81168ABE	195	F 10X1	F 10X1
C81170ABE	250	F 10X1	F 10X1
C81171ABE	325	F 10X1	F 10X1
C81173ABE	205	F 10X1	F 10X1
C81174ABE	530	F 10X1	F 10X1
C81175ABE	410	F 10X1	F 10X1
C81218ABE	225	F 10X1	F 10X1
C81225ABE	170	F 10X1	F 10X1
C81238ABE	168	F 10X1	F 10X1

C82130ABE	365	F 10X1	F 10X1
C84137ABE	245	F 10X1	F 10X1
			
ABE	długość mm	końcówka A	końcówka B
C84146ABE	600	F 10X1	M 10X1
C84147ABE	420	F 10X1	M 10X1
C85110ABE	455	F 10X1	M 10X1
C85113ABE	460	F 10X1	M 10X1
C85115ABE	560	F 10X1	M 10X1
C86141ABE	505	F 10X1	M 10X1
			
ABE	długość mm	końcówka A	końcówka B
C85225ABE	222	F 10X1	F 10X1
C85135ABE	236	F 10X1	F 10X1
C85214ABE	206	F 10X1	F 10X1
C85222ABE	222	F 10X1	F 10X1
C85225ABE	222	F 10X1	F 10X1
C85226ABE	280	F 10X1	F 10X1
C86128ABE	222	F 10X1	F 10X1
C86131ABE	276	F 10X1	F 10X1
C86146ABE	245	F 10X1	F 10X1
C86148ABE	265	F 10X1	F 10X1
C87103ABE	375	F 10X1	F 10X1
C87168ABE	230	F 10X1	F 10X1
C87173ABE	435	F 10X1	F 10X1
C87179ABE	320	F 10X1	F 10X1
C87180ABE	332	F 10X1	F 10X1
C87185ABE	236	F 10X1	F 10X1
C87187ABE	215	F 10X1	F 10X1
C87188ABE	206	F 10X1	F 10X1
C87211ABE	288	F 10X1	F 10X1
C87212ABE	305	F 10X1	F 10X1
C87214ABE	290	F 10X1	F 10X1
C87216ABE	276	F 10X1	F 10X1
C87226ABE	270	F 10X1	F 10X1
C87235ABE	287	F 10X1	F 10X1
C87240ABE	308	F 10X1	F 10X1
C87245ABE	250	F 10X1	F 10X1
C87252ABE	270	F 10X1	F 10X1
C87260ABE	270	F 10X1	F 10X1
C87262ABE	188	F 10X1	F 10X1
C88133ABE	276	F 10X1	F 10X1
C88295ABE	265	F 10X1	F 10X1
			

8

9

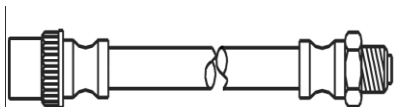

ABE	długość mm	końcówka A	końcówka B
C81023ABE	358	F 12X1	M 10X1
C81060ABE	354	F 10X1	M 10X1
C84145ABE	340	F 10X1	M 10X1
C85104ABE	330	F 10X1	M 10X1
C85105ABE	355	F 10X1	M 10X1
C85108ABE	315	F 10X1	M 10X1
C85109ABE	532	F 10X1	M 10X1
C85112ABE	545	F 10X1	M 10X1
C85124ABE	330	F 10X1	M 10X1
C85134ABE	470	F 10X1	M 10X1
C85136ABE	595	F 10X1	M 10X1
C85141ABE	515	F 10X1	M 10X1
C85143ABE	315	F 10X1	M 10X1
C85216ABE	233	F 10X1	M 10X1
C85227ABE	258	F 10X1	M 10X1
C86101ABE	455	F 10X1	M 10X1
C86106ABE	355	F 10X1	M 10X1
C86108ABE	470	F 10X1	M 10X1
C86119ABE	400	F 10X1	M 10X1
C86127ABE	315	F 10X1	M 10X1
C86133ABE	485	F 10X1	M 10X1
C86134ABE	578	F 10X1	M 10X1
C86143ABE	435	F 10X1	M 10X1
C86145ABE	555	F 10X1	M 10X1
C86207ABE	225	F 10X1	M 10X1
C87102ABE	330	F 10X1	M 10X1
C87106ABE	290	F 10X1	M 10X1
C87107ABE	270	F 10X1	M 10X1
C87108ABE	350	F 10X1	M 10X1
C87109ABE	420	F 10X1	M 10X1
C87114ABE	480	F 10X1	M 10X1
C87115ABE	249	F 10X1	M 10X1
C87125ABE	330	F 10X1	M 10X1
C87131ABE	485	F 10X1	M 10X1
C87134ABE	430	F 10X1	M 10X1
C87136ABE	315	F 10X1	M 10X1
C87139ABE	329	F 10X1	M 10X1
C87144ABE	350	F 10X1	M 10X1
C87146ABE	350	F 10X1	M 10X1
C87148ABE	268	F 10X1	M 10X1
C87150ABE	420	F 10X1	M 10X1
C87159ABE	360	F 10X1	M 10X1
C87161ABE	410	F 10X1	M 10X1
C87170ABE	435	F 10X1	M 10X1
C87175ABE	350	F 10X1	M 10X1
C87181ABE	310	F 10X1	M 10X1
C87186ABE	515	F 10X1	M 10X1
C87221ABE	465	F 10X1	M 10X1
C87230ABE	330	F 10X1	M 10X1

C87232ABE	180	F 10X1	M 10X1
C87233ABE	330	F 10X1	M 10X1
C87237ABE	420	F 10X1	M 10X1
C87238ABE	330	F 10X1	M 10X1
C87251ABE	375	F 10X1	M 10X1
C87255ABE	410	F 10X1	M 10X1
C87256ABE	466	F 10X1	M 10X1
C88296ABE	330	F 10X1	M 10X1
C88297ABE	465	F 10X1	M 10X1

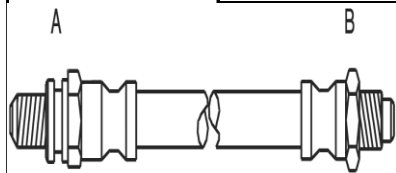

11

ABE	długość mm	końcówka A	końcówka B
C81027ABE	525	M 12X1	M 12X1
C83113ABE	352	M 10X1	M 10X1
C83153ABE	390	M 10X1	M 10X1
C83154ABE	335	M 10X1	M 10X1
C83155ABE	460	M 10X1	M 10X1

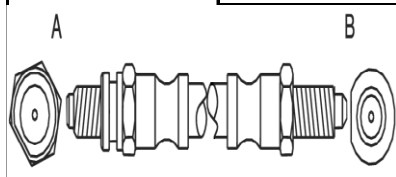

12

ABE	długość mm	końcówka A	końcówka B
C83152ABE	580	M 10X1	M 10X1
C83209ABE	283	M 10X1	M 10X1
C83210ABE	307	M 10X1	M 10X1
C83215ABE	333	M 10X1	M 10X1
C87183ABE	305	M 10X1	M 10X1
C88173ABE	240	M 10X1	M 10X1

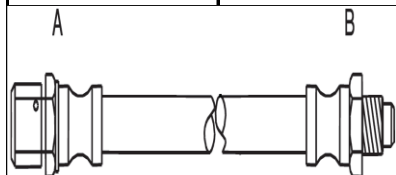

13

ABE	długość mm	końcówka A	końcówka B
C82206ABE	375	F 10X1	M 12X1,5

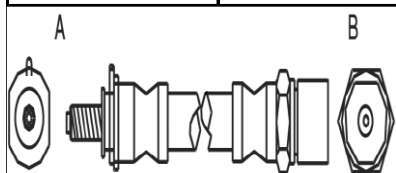

14

ABE	długość mm	końcówka A	końcówka B
C81602ABE	238	M 10X1	F 10X1
C81615ABE	245	M 10X1	F 10X1
C81604ABE	248	M 10X1	F 10X1
C84211ABE	237	M 10X1	F 10X1

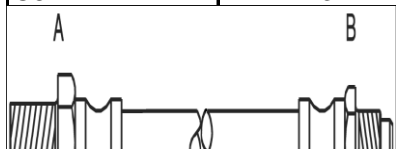

15

ABE	długość mm	końcówka A	końcówka B
C80465ABE	680	M16X1,5+F12X1	M12X1
C80466ABE	810	M16X1,5+F12X1	M12X1
C80834ABE	200	M 5/8 26 + F3/8 24	M 3/8 24
C80846ABE	300	M 5/8 26 + F3/8 24	M 3/8 24
C81022ABE	276	M 5/8 26 + F3/8 24	M 3/8 24
C81819ABE	425	M 5/8 26 + F3/8 24	M 3/8 24
C81939ABE	550	M 20X1,5 + F 14X1,5	M 10X1,25

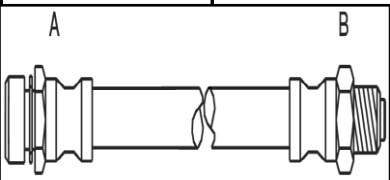

ABE	długość mm	końcówka A	końcówka B
C80102ABE	185	F 10X1	M 10X1
C80108ABE	350	F 10X1	M 10X1
C80128ABE	320	F 10X1	M 10X1
C80139ABE	300	F 10X1	M 10X1
C80140ABE	285	F 10X1	M 10X1
C80143ABE	440	F 10X1	M 10X1
C80145ABE	385	F 10X1	M 10X1
C80146ABE	305	F 10X1	M 10X1
C80150ABE	480	F 10X1	M 10X1
C80151ABE	255	F 10X1	M 10X1
C80169ABE	495	F 10X1	M 10X1
C80176ABE	460	F 10X1	M 10X1
C80403ABE	415	F 10X1	M 10X1
C80404ABE	520	F 10X1	M 10X1
C80405ABE	466	F 10X1	M 10X1
C80406ABE	280	F 10X1	M 10X1
C80412ABE	320	F 10X1	M 10X1
C80413ABE	335	F 10X1	M 10X1
C80417ABE	470	F 10X1	M 10X1
C80502ABE	170	F 10X1	M 10X1
C80503ABE	210	F 10X1	M 10X1
C80506ABE	205	F 10X1	M 10X1

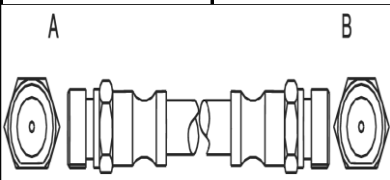

ABE	długość mm	końcówka A	końcówka B
C80604ABE	230	F 10X1	F 10X1
C80605ABE	220	F 10X1	F 10X1
C80607ABE	245	F 10X1	F 10X1
C80608ABE	380	F 10X1	F 10X1
C83141ABE	355	F 10X1	F 10X1
C83144ABE	385	F 10X1	F 10X1
C84106ABE	327	F 10X1	F 10X1
C84123ABE	275	F 10X1	F 10X1
C84124ABE	410	F 10X1	F 10X1

16

17

C84126ABE	215	F 10X1	F 10X1
C84207ABE	335	F 10X1	F 10X1
C84209ABE	234	F 10X1	F 10X1
C88150ABE	265	F 10X1,25	F 10X1,25
C88154ABE	200	F 10X1,25	F 10X1,25

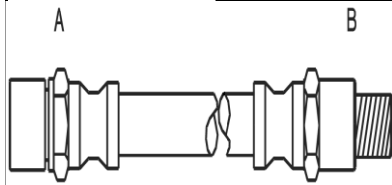

18

ABE			
ABE	długość mm	końcówka A	końcówka B
C80333ABE	340	F 3/8X24	M 3/8X24
C82002ABE	345	F 10X1,25	M 10X1,25
C87101ABE	430	F 3/8 24	M 3/8 24
C87117ABE	272	F 3/8 24	M 3/8 24
C87141ABE	365	F 3/8 24	M 3/8 24
C87153ABE	345	F 3/8 24	M 3/8 24
C87166ABE	510	F 3/8 24	M 3/8 24
C87190ABE	293	F 10X1	M 10X1
C87193ABE	290	F 10X1	M 10X1
C87194ABE	470	F 3/8 24	M 3/8 24
C87195ABE	323	F 10X1	M 10X1
C87218ABE	230	F 3/8 24	M 3/8 24
C87254ABE	332	F 3/8 24	M 3/8 24

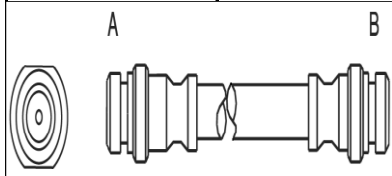

19

ABE			
ABE	długość mm	końcówka A	końcówka B
C80036ABE	315	F 10X1	F 10X1
C80037ABE	241	F 10X1	F 10X1
C80039ABE	355	F 10X1	F 10X1
C80039ABE	355	F 10X1	F 10X1
C80045ABE	230	F 10X1	F 10X1
C80049ABE	280	F 3/8 24	F 3/8 24
C80050ABE	340	F 10X1	F 10X1
C80119ABE	285	F 10X1	F 10X1
C80156ABE	325	F 10X1	F 10X1
C80157ABE	220	F 10X1	F 10X1
C80167ABE	270	F 12X1	F 12X1
C80183ABE	290	F 10X1	F 10X1
C81501ABE	335	F 10X1	F 10X1
C81524ABE	320	F 10X1	F 10X1
C82003ABE	265	F 10X1	F 10X1
C82005ABE	295	F 10X1	F 10X1
C82010ABE	290	F 10X1	F 10X1
C82029ABE	345	F 10X1	F 10X1

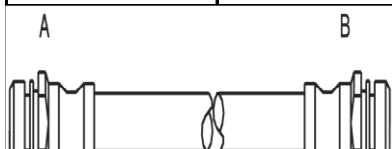

20

ABE	długość mm	końcówka A	końcówka B
C80501ABE	317	F 10X1	F 10X1
C80504ABE	305	F 10X1	F 10X1
C80505ABE	267	F 10X1	F 10X1
C80507ABE	260	F 10X1	F 10X1
C80518ABE	340	F 10X1	F 10X1
C80522ABE	290	F 10X1	F 10X1
C80523ABE	223	F 10X1	F 10X1

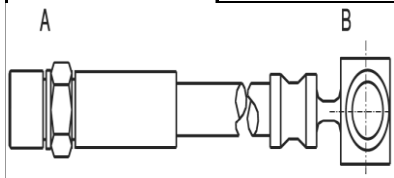

21

ABE	długość mm	końcówka A	końcówka B
C84112ABE	440	F 10X1	∅10
C84118ABE	340	F 10X1	∅10
C84130ABE	409	F 10X1	∅10
C84141ABE	300	F 10X1	∅10
C84148ABE	415	F 10X1	∅10
C84149ABE	300	F 10X1	∅10
C84150ABE	206	F 10X1	∅10

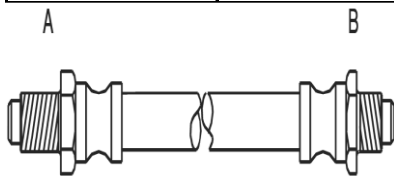

22

ABE	długość mm	końcówka A	końcówka B
C80120ABE	210	M 10X1	M 10X1
C80652ABE	395	M 10X1	M 10X1
C80665ABE	180	M 10X1	M 12X1
C80702ABE	342	M 10X1	M 10X1
C80720ABE	580	M 12X1	M 12X1
C80809ABE	308	M 10X1	M 10X1
C80818ABE	325	M 10X1	M 10X1
C80829ABE	195	M 10X1	M 10X1
C80830ABE	295	M 12X1	M 12X1
C80835ABE	265	M 12X1	M 12X1
C80836ABE	240	M 7/16 20	M 12X1
C80838ABE	325	M 10X1	M 10X1
C80842ABE	280	M 10X1	M 10X1
C80845ABE	205	M 10X1	M 10X1
C80852ABE	243	M 10X1	M 10X1
C81014ABE	475	M 10X1	M 10X1
C81015ABE	373	M 10X1	M 10X1
C81016ABE	390	M 10X1	M 10X1
C81019ABE	448	M 10X1	M 10X1
C81021ABE	465	M 10X1	M 10X1
C81026ABE	306	M 12X1	M 12X1
C81612ABE	320	M 10X1	M 10X1
C81614ABE	305	M 10X1	M 10X1
C81703ABE	370	M 10X1	M 10X1
C81705ABE	520	M 10X1	M 10X1

C81709ABE	395	M 10X1	M 10X1
C81710ABE	405	M 3/8 24	M 3/8 24
C81711ABE	475	M 10X1	M 10X1
C81802ABE	360	M 7/16 20	M 12X1
C81806ABE	395	M 10X1	M 10X1
C81807ABE	435	M 10X1	M 10X1
C81814ABE	355	M 10X1	M 10X1
C81817ABE	410	M 10X1	M 10X1
C81921ABE	415	M 10X1	M 10X1
C83101ABE	410	M 10X1	M 10X1
C83102ABE	313	M 10X1	M 10X1
C83104ABE	437	M 10X1	M 10X1
C83105ABE	370	M 10X1	M 10X1
C83108ABE	530	M 10X1	M 10X1
C83111ABE	425	M 10X1	M 10X1
C83138ABE	180	M 10X1	M 10X1
C83140ABE	243	M 10X1	M 10X1
C83147ABE	220	M 10X1	M 10X1
C83148ABE	265	M 10X1	M 10X1
C83159ABE	235	M 10X1	M 10X1
C83206ABE	490	M 10X1	M 10X1

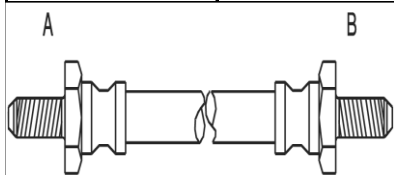

ABE	długość mm	końcówka A	końcówka B
C80141ABE	240	M 10X1	M 10X1
C80142ABE	170	M 10X1	M 10X1
C80144ABE	230	M 10X1	M 10X1
C80148ABE	195	M 10X1	M 10X1
C80415ABE	210	M 10X1	M 10X1
C80415ABE	305	M 10X1	M 10X1
C80416ABE	230	M 10X1	M 10X1
C80519ABE	520	M 10X1	M 10X1
C80520ABE	340	M 10X1	M 10X1
C80806ABE	555	M 10X1	M 10X1
C80823ABE	300	M 10X1	M 10X1
C80831ABE	295	M 3/8 24	M 3/8 24
C80839ABE	308	M 10X1	M 10X1
C80840ABE	370	M 3/8 24	M 3/8 24
C80841ABE	255	M 10X1	M 10X1
C80843ABE	335	M 3/8 24	M 3/8 24
C80844ABE	200	M 10X1	M 10X1
C80847ABE	205	M 3/8 24	M 3/8 24
C80849ABE	240	M 10X1	M 10X1
C80851ABE	330	M 10X1	M 10X1
C81011ABE	450	M 10X1	M 10X1
C81025ABE	380	M 3/8 24	M 3/8 24
C81145ABE	180	M 10X1	M 10X1
C81160ABE	390	M 10X1	M 10X1
C81613ABE	323	M 10X1	M 10X1
C81701ABE	555	M 10X1	M 10X1

C81702ABE	405	M 10X1	M 10X1
C81704ABE	445	M 10X1	M 10X1
C81810ABE	295	M 7/16 20	M 7/16 20
C81812ABE	335	M 7/16 20	M 7/16 20
C81815ABE	252	M 7/16 20	M 7/16 20
C81818ABE	370	M 10X1	M 10X1
C81820ABE	465	M 3/8 24	M 3/8 24
C81821ABE	404	M 10X1	M 10X1
C81822ABE	370	M 3/8 24	M 3/8 24
C81825ABE	408	M 3/8 24	M 3/8 24
C83112ABE	535	M 10X1	M 10X1
C83139ABE	360	M 10X1	M 10X1
C83145ABE	460	M 10X1	M 10X1
C83156ABE	357	M 10X1	M 10X1

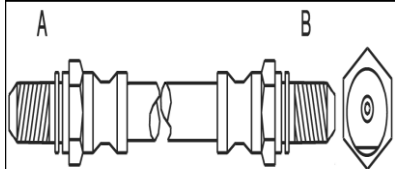

24

ABE	długość mm	końcówka A	końcówka B
C83150ABE	435	M 10X1	M 10X1
C83203ABE	345	M 10X1	M 10X1
C83207ABE	341	M 10X1	M 10X1
C83214ABE	341	M 10X1	M 10X1

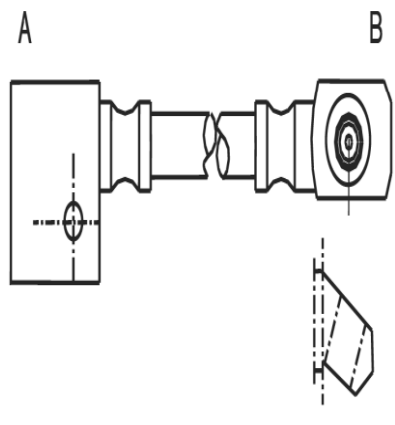

25

ABE	długość mm	końcówka A	końcówka B
C84105ABE	335	F 10X1	ø10
C84101ABE	335	F 10X1	ø10

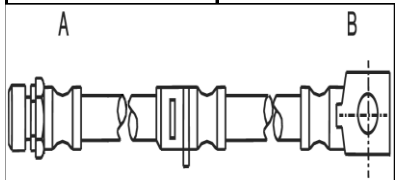

26

ABE	długość mm	końcówka A	końcówka B
C84110ABE	445	F 10X1	ø10
C84125ABE	416	F 10X1	ø10
C84127ABE	465	F 10X1	ø10
C84129ABE	427	F 10X1	ø10
C84133ABE	386	F 10X1	ø10

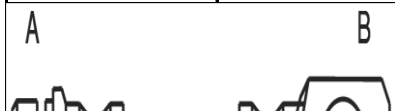

27

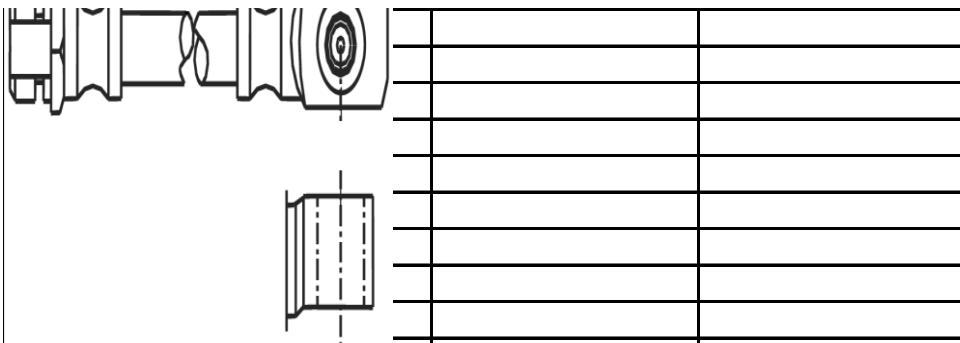

ABE	długość mm	końcówka A	końcówka B
C81310ABE	415	F 10X1	ø10
C81609ABE	340	F 10X1	ø10
C81920ABE	322	F 10X1	ø10
C84104ABE	395	F 10X1	ø10
C84115ABE	340	F 10X1	ø10
C84117ABE	430	F 10X1	ø10
C84128ABE	412	F 10X1	ø10

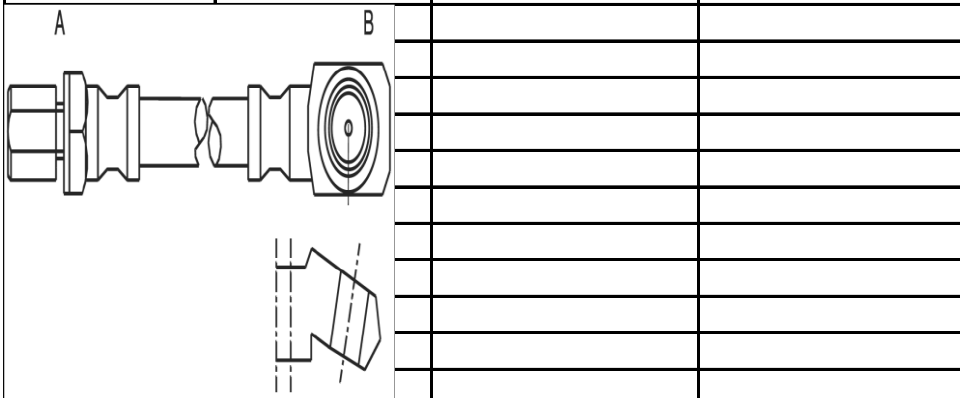

ABE	długość mm	końcówka A	końcówka B
C84108ABE	340	F 10X1	ø10
C84102ABE	303	F 10X1	ø10
C81520ABE	360	F 10X1	ø10
C80603ABE	335	F 10X1	ø10
C84113ABE	330	F 10X1	ø10

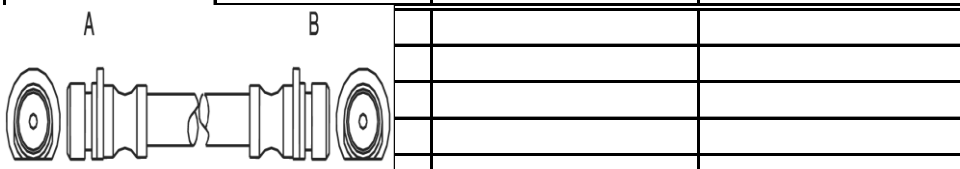

ABE	długość mm	końcówka A	końcówka B
C89212ABE	390	F 10X1	F 10X1
C89139ABE	290	F 10X1	F 10X1
C89216ABE	265	F 10X1	F 10X1
C80828ABE	235	F 10X1	F 10X1
C81801ABE	390	F 10X1	F 10X1
C80805ABE	290	F 10X1	F 10X1
C81801ABE	398	F 10X1	F 10X1
C89141ABE	310	F 10X1	F 10X1
C89156ABE	285	F 10X1	F 10X1
C89159ABE	405	F 10X1	F 10X1
C89207ABE	235	F 10X1	F 10X1
C89209ABE	255	F 10X1	F 10X1

28

29

C89216ABE	275	F 10X1	F 10X1
C89144ABE	380	F 10X1	F 10X1
C80812ABE	380	F 10X1	F 10X1
C89216ABE	270	F 10X1	F 10X1
C80163ABE	320	F 3/8 24	F 3/8 24

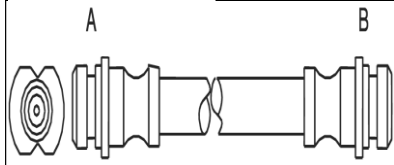

30

ABE	długość mm	końcówka A	końcówka B
C80602ABE	235	F 10X1	F 10X1
C80615ABE	240	F 10X1	F 10X1
C81510ABE	290	F 10X1	F 10X1
C82011ABE	330	F 10X1	F 10X1

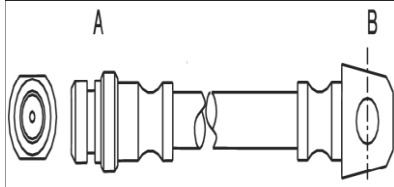

31

ABE	długość mm	końcówka A	końcówka B
C81504ABE	340	F 10X1	ø10
C81505ABE	340	F 10X1	ø10

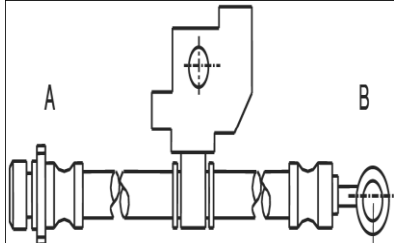

32

ABE	długość mm	końcówka A	końcówka B
C80824ABE	398	F 10X1	ø10
C80827ABE	475	F 10X1	ø10
C80832ABE	490	F 10X1	ø10
C89103ABE	485	F 10X1	ø10
C89119ABE	710	F 10X1	ø10
C89120ABE	475	F 10X1	ø10
C89120ABE	475	F 10X1	ø10
C89121ABE	470	F 10X1	ø10
C89122ABE	655	F 10X1	ø10
C89123ABE	655	F 10X1	ø10
C89124ABE	450	F 10X1	ø10
C89124ABE	450	F 10X1	ø10
C89125ABE	430	F 10X1	ø10
C89126ABE	675	F 10X1	ø10
C89133ABE	459	F 10X1	ø10
C89133ABE	455	F 10X1	ø10
C89134ABE	435	F 10X1	ø10
C89135ABE	675	F 10X1	ø10
C89138ABE	455	F 10X1	ø10
C89170ABE	560	F 10X1	ø10
C89171ABE	560	F 10X1	ø10

C89172ABE	470	F 10X1	ø10
C89173ABE	470	F 10X1	ø10
C89174ABE	580	F 10X1	ø10
C89175ABE	580	F 10X1	ø10
C89227ABE	525	F 10X1	ø10
C89229ABE	430	F 10X1	ø10
C89230ABE	430	F 10X1	ø10
C89231ABE	483	F 10X1	ø10
C89231ABE	485	F 10X1	ø10
C89232ABE	575	F 10X1	ø10
C89236ABE	485	F 10X1	ø10
C89237ABE	485	F 10X1	ø10

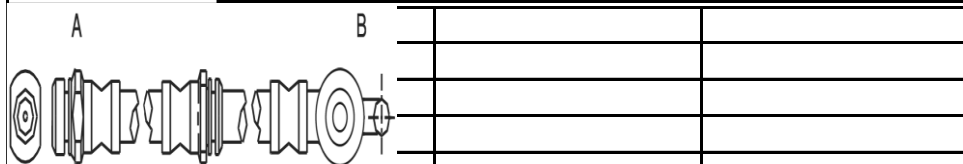

33

ABE	długość mm	końcówka A	końcówka B
C83136ABE	315	F 10X1	ø10
C80043ABE	430	F 10X1	ø10
C80718ABE	428	F 10X1	ø10
C80042ABE	470	F 10X1	ø10
C80414ABE	475	F 10X1	ø10
C80134ABE	480	F 10X1	ø10
C80135ABE	480	F 10X1	ø10
C80133ABE	540	F 10X1	ø10
C80138ABE	540	F 10X1	ø10
C81900ABE	480	F 10X1	ø10
C82007ABE	440	F 10X1	ø10
C82009ABE	547	F 10X1	ø10
C82008ABE	465	F 10X1	ø10
C82028ABE	302	F 10X1	ø10
C81580ABE	440	F 10X1	ø10
C82021ABE	508	F 10X1	ø10
C80044ABE	230	F 10X1	ø10
C80132ABE	540	F 10X1	ø10
C80137ABE	540	F 10X1	ø10
C82001ABE	480	F 10X1	ø10
C82006ABE	320	F 10X1	ø10
C82014ABE	490	F 10X1	ø10
C82015ABE	520	F 10X1	ø10
C82018ABE	445	F 10X1	ø10
C82019ABE	385	F 10X1	ø10
C82020ABE	430	F 10X1	ø10
C82021ABE	515	F 10X1	ø10
C81970ABE	544	F 10X1	ø10

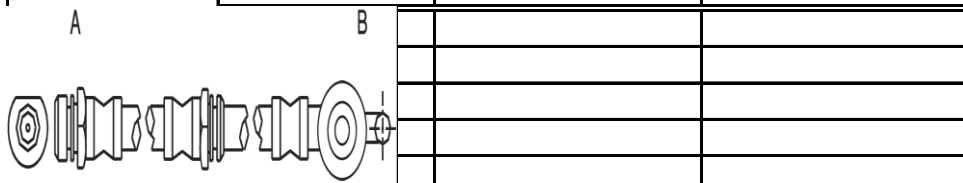

34

ABE	długość mm	końcówka A	końcówka B
C80660ABE	485	F 10X1	ø10

C80609ABE	380	F 10X1	ø10
C80610ABE	375	F 10X1	ø10
C80612ABE	425	F 10X1	ø10
C80613ABE	425	F 10X1	ø10
C80616ABE	380	F 10X1	ø10

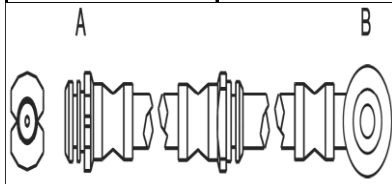

35

ABE	długość mm	końcówka A	końcówka B
C80601ABE	460	F 10X1	ø10
C80614ABE	435	F 10X1	ø10
C81506ABE	485	F 10X1	ø10
C81508ABE	560	F 10X1	ø10

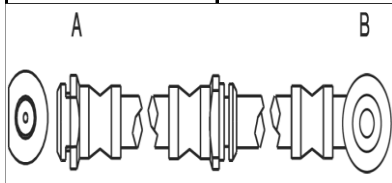

36

ABE	długość mm	końcówka A	końcówka B
C80807ABE	500	F 10X1	ø10
C84140ABE	443	F 10X1	ø10
C80611ABE	555	F 10X1	ø10
C89114ABE	540	F 10X1	ø10
C89115ABE	500	F 10X1	ø10

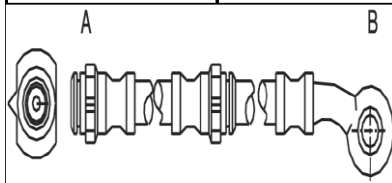

37

ABE	długość mm	końcówka A	końcówka B
C80808ABE	645	F 10X1	ø10
C80816ABE	500	F 10X1	ø10
C81503ABE	520	F 10X1	ø10
C81511ABE	515	F 10X1	ø10
C81516ABE	490	F 10X1	ø10
C81518ABE	548	F 10X1	ø10
C81519ABE	483	F 10X1	ø10
C81521ABE	500	F 10X1	ø10
C81536ABE	480	F 10X1	ø10
C81537ABE	484	F 10X1	ø10
C81538ABE	567	F 10X1	ø10
C81540ABE	565	F 10X1	ø10
C81541ABE	565	F 10X1	ø10
C81543ABE	520	F 10X1	ø10
C81544ABE	590	F 10X1	ø10
C81545ABE	615	F 10X1	ø10
C81547ABE	525	F 10X1	ø10
C81548ABE	410	F 10X1	ø10
C81549ABE	420	F 10X1	ø10
C81550ABE	585	F 10X1	ø10
C81553ABE	615	F 10X1	ø10

C81592ABE	610	F 10X1	ø10
C81593ABE	610	F 10X1	ø10
C81800ABE	445	F 10X1	ø10
C81971ABE	436	F 10X1	ø10
C84116ABE	455	F 10X1	ø10
C84135ABE	436	F 10X1	ø10

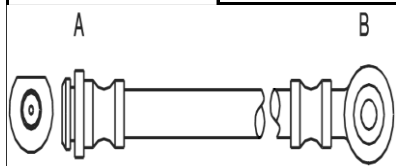

ABE	długość mm	końcówka A	końcówka B
C80606ABE	415	F 10X1	ø10
C80663ABE	545	F 10X1	ø10
C80811ABE	225	F 10X1	ø10
C81571ABE	225	F 10X1	ø10
C81601ABE	335	F 10X1	ø10
C82118ABE	585	F 10X1	ø10
C82219ABE	465	F 10X1	ø10
C84120ABE	410	F 10X1	ø10
C84122ABE	335	F 10X1	ø10
C84221ABE	240	F 10X1	ø10
C89106ABE	480	F 10X1	ø10
C89113ABE	500	F 10X1	ø10
C89152ABE	445	F 10X1	ø10
C89157ABE	670	F 10X1	ø10
C89158ABE	675	F 10X1	ø10
C89164ABE	465	F 10X1	ø10
C89167ABE	455	F 10X1	ø10
C89168ABE	455	F 10X1	ø10
C89169ABE	525	F 10X1	ø10
C89217ABE	220	F 10X1	ø10
C89218ABE	225	F 10X1	ø10

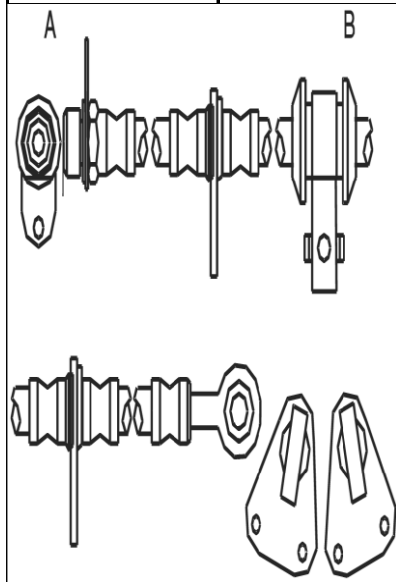

ABE	długość mm	końcówka A	końcówka B
C89101ABE	485	F 10X1	ø10
C89102ABE	490	F 10X1	ø10
C89142ABE	560	F 10X1	ø10

38

39

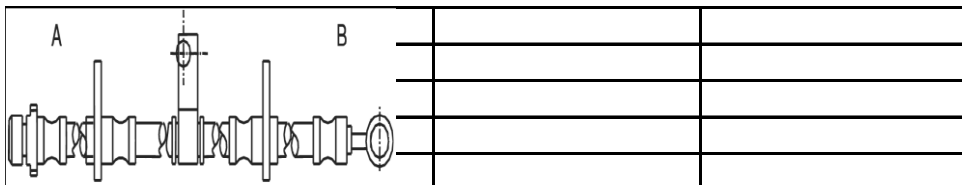

40

ABE	długość mm	końcówka A	końcówka B
C80800ABE	685	F 10X1	ø10
C80801ABE	705	F 10X1	ø10
C80802ABE	695	F 10X1	ø10
C80817ABE	560	F 10X1	ø10
C89104ABE	655	F 10X1	ø10
C89105ABE	655	F 10X1	ø10
C89143ABE	686	F 10X1	ø10
C89150ABE	705	F 10X1	ø10
C89151ABE	705	F 10X1	ø10
C89153ABE	717	F 10X1	ø10
C89154ABE	713	F 10X1	ø10
C89155ABE	695	F 10X1	ø10
C89163ABE	710	F 10X1	ø10

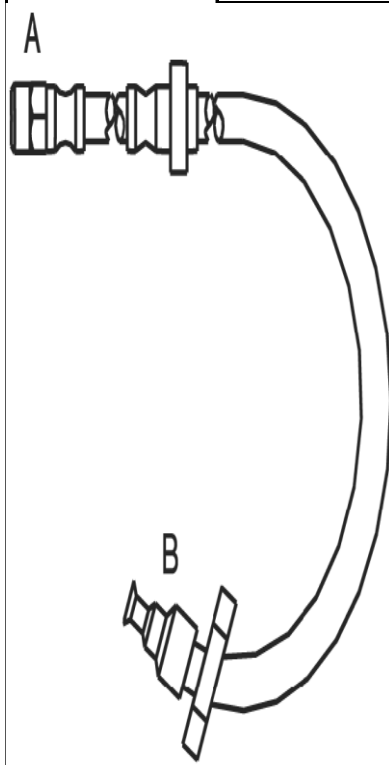

41

ABE	długość mm	końcówka A	końcówka B
C81400ABE		F 12X1	F 12X1
C81401ABE		F 12X1	F 12X1
C81402ABE		F 12X1	F 12X1
C81403ABE		F 12X1	F 12X1

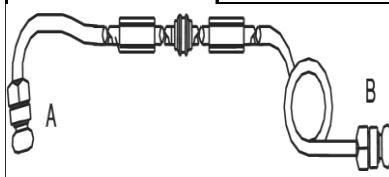

42

ABE	długość mm	końcówka A	końcówka B
C82000ABE	600	M 12X1	M 12X1



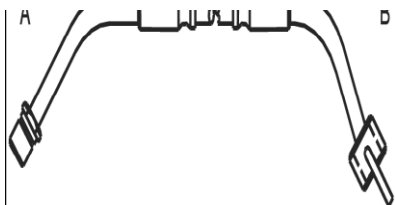

43

ABE	długość mm	końcówka A	końcówka B
C83118ABE	279	F 10X1	ø10
C83119ABE	279	F 10X1	ø10
C83120ABE	285	F 10X1	ø10
C83121ABE	285	F 10X1	ø10
C83122ABE	429	F 10X1	ø10
C83123ABE	429	F 10X1	ø10

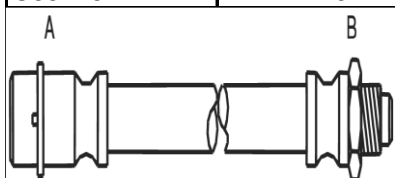

44

ABE	długość mm	końcówka A	końcówka B
C80722ABE	395	F 10X1	M 10X1
C80206ABE	455	F 10X1	M 10X1
C80208ABE	380	F 10X1	M 10X1
C80804ABE	527	F 10X1	M 10X1
C81172ABE	335	F 10X1	M 10X1
C82112ABE	413	F 10X1	M 10X1
C82131ABE	310	F 10X1	M 10X1
C82132ABE	308	F 10X1	M 10X1

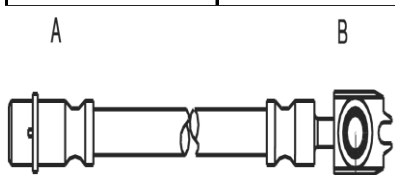

45

ABE	długość mm	końcówka A	końcówka B
C81166ABE	520	F 10X1	ø10
C81167ABE	290	F 10X1	ø10
C81181ABE	430	F 10X1	ø10
C80007ABE	450	F 10X1	ø10
C80011ABE	550	F 10X1	ø10
C81001ABE	498	F 10X1	ø10
C81053ABE	392	F 10X1	ø10
C81133ABE	392	F 10X1	ø10
C81136ABE	450	F 10X1	ø10
C81137ABE	435	F 10X1	ø10
C81150ABE	325	F 10X1	ø12,3
C81157ABE	205	F 10X1	ø12,3

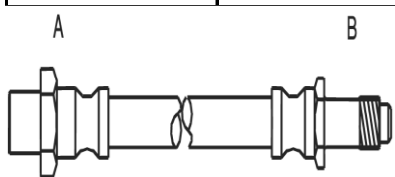

46

ABE	długość mm	końcówka A	końcówka B
C80209ABE	450	F 10X1	M 10X1
C80212ABE	320	F 10X1	M 10X1

C80213ABE	502	F 10X1	M 10X1
C80215ABE	300	F 10X1	M 10X1
C80719ABE	365	F 10X1	M 10X1
C80721ABE	420	F 10X1	M 10X1
C80724ABE	380	F 10X1	M 10X1
C81008ABE	485	F 10X1	M 10X1
C81052ABE	357	F 10X1	M 10X1
C81055ABE	187	F 10X1	M 10X1
C81062ABE	355	F 10X1	M 10X1
C81102ABE	485	F 10X1	M 10X1
C81156ABE	498	F 10X1	M 10X1
C81158ABE	187	F 10X1	M 10X1
C81165ABE	420	F 10X1	M 10X1
C82141ABE	405	F 10X1	M 10X1

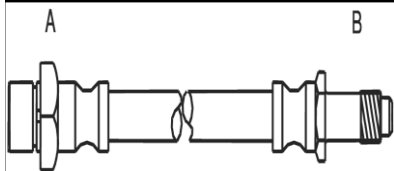

47

ABE	długość mm	końcówka A	końcówka B
C80016ABE	365	F 10X1	M 10X1
C81002ABE	465	F 10X1	M 10X1
C83116ABE	420	F 10X1	M 10X1
C83117ABE	435	F 10X1	M 10X1
C83135ABE	465	F 10X1	M 10X1
C83158ABE	187	F 10X1	M 10X1
C83161ABE	600	F 12X1	M 12X1
C83170ABE	420	F 10X1	M 10X1
C83171ABE	420	F 10X1	M 10X1
C83172ABE	348	F 10X1	M 10X1
C83174ABE	430	F 10X1	M 10X1

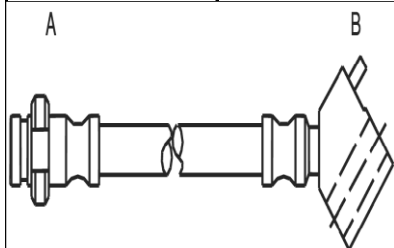

48

ABE	długość mm	końcówka A	końcówka B
C81502ABE	360	F 10X1	F 10X1

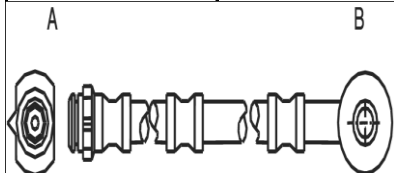

49

ABE	długość mm	końcówka A	końcówka B
C89160ABE	385	F 10X1	ø10
C89110ABE	470	F 10X1	ø10



50

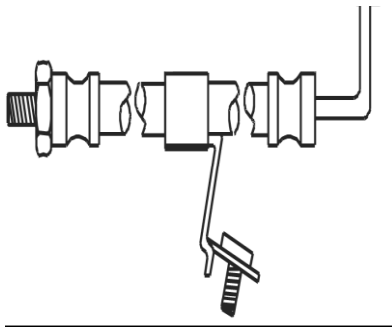

ABE	długość mm	końcówka A	końcówka B
C83124ABE	425	M 10X1	ø10
C83125ABE	425	M 10X1	ø10

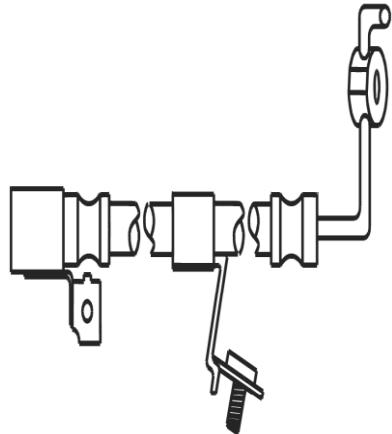

ABE	długość mm	końcówka A	końcówka B
C83126ABE	407	F 10X1	ø10
C83127ABE	407	F 10X1	ø10
C83136ABE	315	F 10X1	ø10

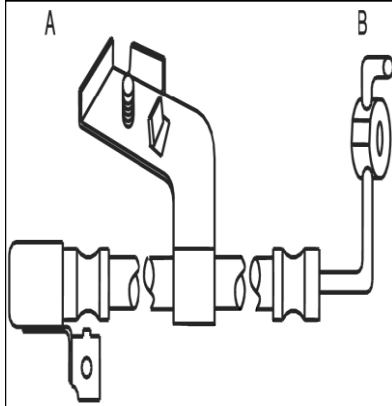

ABE	długość mm	końcówka A	końcówka B
C83129ABE	361	F 10X1	ø10
C83128ABE	361	F 10X1	ø10
C83137ABE	320	F 10X1	ø10

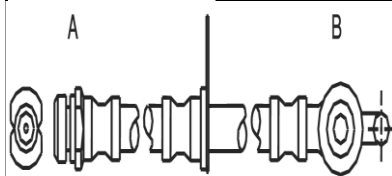

ABE	długość mm	końcówka A	końcówka B
C80110ABE	360	F 10X1	ø10
C80177ABE	595	F 10X1	ø10

51

52

53

C80178ABE	595	F 10X1	ø10
C80179ABE	265	F 10X1	ø10
C80180ABE	460	F 10X1	ø10
C80181ABE	460	F 10X1	ø10
C80182ABE	235	F 10X1	ø10
C80184ABE	585	F 10X1	ø10
C80185ABE	585	F 10X1	ø10
C80186ABE	235	F 10X1	ø10

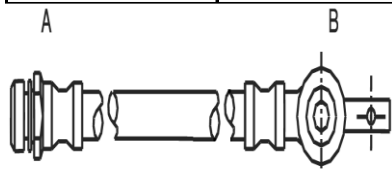

54

ABE	długość mm	końcówka A	końcówka B
C80054ABE	425	F 10X1	ø10
C80112ABE	560	F 10X1	ø10
C80113ABE	370	F 10X1	ø10
C80127ABE	480	F 10X1	ø10
C80131ABE	515	F 10X1	ø10
C80136ABE	515	F 10X1	ø10
C80153ABE	290	F 10X1	ø10
C80166ABE	536	F 10X1	ø10
C80168ABE	484	F 10X1	ø10
C80170ABE	500	F 10X1	ø10

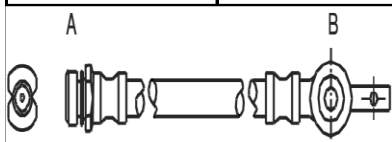

55

ABE	długość mm	końcówka A	końcówka B
C80114ABE	540	F 10X1	ø10
C80115ABE	540	F 10X1	ø10
C80116ABE	500	F 10X1	ø10
C80152ABE	415	F 10X1	ø10
C81805ABE	230	F 10X1	ø10

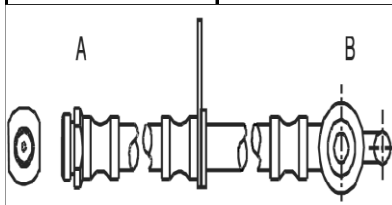

56

ABE	długość mm	końcówka A	końcówka B
C80121ABE	275	F 10X1	ø10
C80122ABE	455	F 10X1	ø10
C80123ABE	455	F 10X1	ø10
C80124ABE	473	F 10X1	ø10
C80125ABE	473	F 10X1	ø10
C80126ABE	495	F 10X1	ø10
C80154ABE	540	F 10X1	ø10
C80155ABE	537	F 10X1	ø10

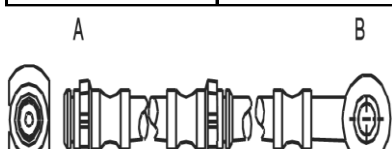

57

ABE	długość mm	końcówka A	końcówka B
C80117ABE	495	F 10X1	∅10
C80118ABE	495	F 10X1	∅10
C80820ABE	545	F 10X1	∅10
C80821ABE	545	F 10X1	∅10
C81517ABE	503	F 10X1	∅10
C81527ABE	225	F 10X1	∅10
C81581ABE	450	F 10X1	∅10
C81582ABE	515	F 10X1	∅10
C81589ABE	470	F 10X1	∅10
C89165ABE	545	F 10X1	∅10
C89166ABE	545	F 10X1	∅10

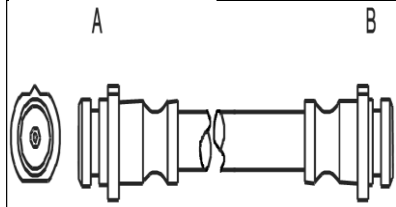

58

ABE	długość mm	końcówka A	końcówka B
C80310ABE	275	F 10X1	F 10X1
C81155ABE	266	F 10X1	F 10X1
C81509ABE	292	F 10X1	F 10X1
C81512ABE	272	F 10X1	F 10X1
C81523ABE	310	F 10X1	F 10X1
C81539ABE	340	F 10X1	F 10X1
C81573ABE	310	F 10X1	F 10X1

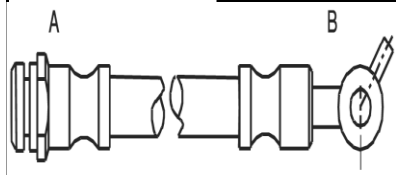

59

ABE	długość mm	końcówka A	końcówka B
C81515ABE	310	F 10X1	∅10

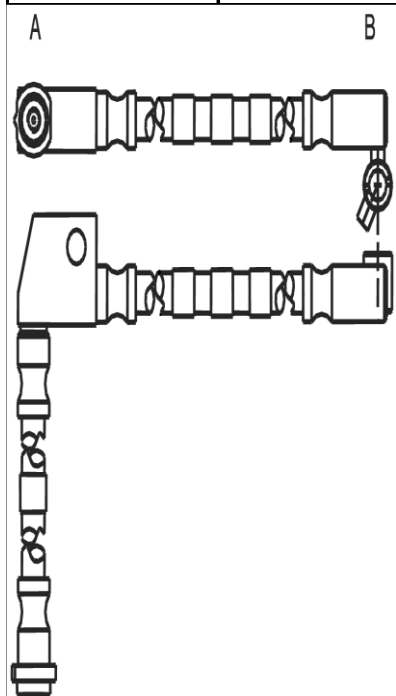

60

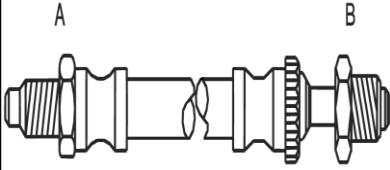
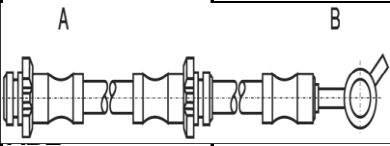
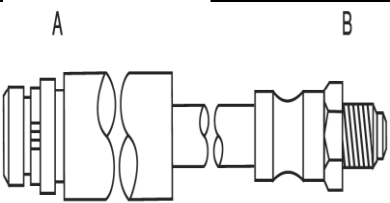
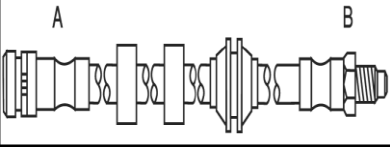
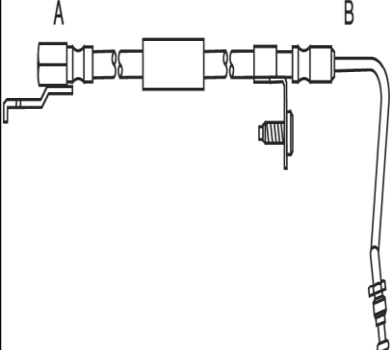
ABE	długość mm	końcówka A	końcówka B
C81514ABE	271+187	F 10X1	ø10
C81513ABE	187+271	F 10X1	ø10
C81542ABE	245/155	F 10X1	ø10
C81551ABE	245/155	F 10X1	ø10
			
61			
ABE	długość mm	końcówka A	końcówka B
C86109ABE	510	M 10X1	M 10X1
			
62			
ABE	długość mm	końcówka A	końcówka B
C81525ABE	475	F 10X1	ø10
			
63			
ABE	długość mm	końcówka A	końcówka B
C83130ABE	340	F 10X1	M 10X1
C83142ABE	480	F 10X1	M 10X1
C83151ABE	568	F 10X1	M 10X1
C83183ABE	355	F 10X1	M 10X1
C83184ABE	420	F 10X1	M 10X1
C83185ABE	425	F 10X1	M 10X1
C83186ABE	175	F 10X1	M 10X1
C83188ABE	430	F 10X1	M 10X1
C83190ABE	420	F 10X1	M 10X1
C83193ABE	460	F 10X1	M 10X1
C83194ABE	300	F 10X1	M 10X1
			
64			
ABE	długość mm	końcówka A	końcówka B
C83131ABE	370	F 10X1	M 10X1
			
65			

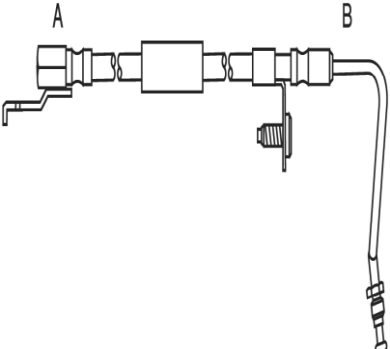
ABE	długość mm	końcówka A	końcówka B
C83232ABE	450	F 10X1	M 10X1
			

66

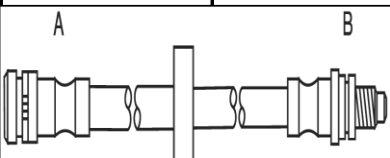
ABE	długość mm	końcówka A	końcówka B
C83233ABE	450	F 10X1	M 10X1
			

67

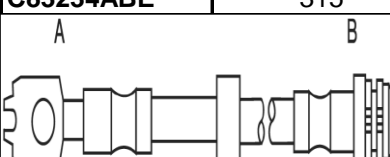
ABE	długość mm	końcówka A	końcówka B
C83234ABE	315	F 10X1	M 10X1
			

68

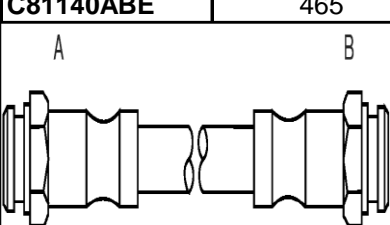
ABE	długość mm	końcówka A	końcówka B
C81140ABE	465	ø10	F 10X1
			

69

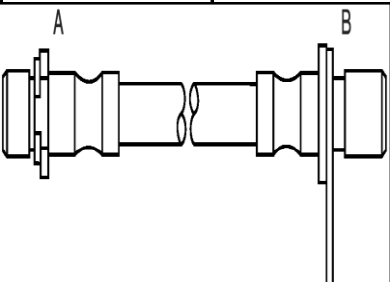
ABE	długość mm	końcówka A	końcówka B
C80652ABE	278	F 10X1	F 10X1
C80654ABE	298	F 10X1	F 10X1
C80656ABE	260	F 10X1	F 10X1
C80659ABE	240	F 10X1	F 10X1
C80667ABE	280	F 10X1	F 10X1
C81004ABE	425	F 10X1	F 10X1
			

70

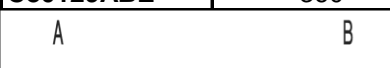
ABE	długość mm	końcówka A	końcówka B
C80129ABE	360	F 10X1	F 10X1
			

71

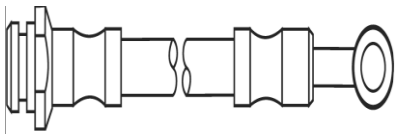

ABE	długość mm	końcówka A	końcówka B
C80303ABE	520	F 10X1	∅10
C80046ABE	555	F 10X1	∅10
C80051ABE	336	F 10X1	∅10
C80300ABE	515	F 10X1	∅10
C80301ABE	515	F 10X1	∅10
C80302ABE	520	F 10X1	∅10
C80305ABE	480	F 10X1	∅10
C80508ABE	490	F 10X1	∅10
C80509ABE	490	F 10X1	∅10
C80510ABE	515	F 10X1	∅10
C80511ABE	515	F 10X1	∅10
C80512ABE	270	F 10X1	∅10
C80513ABE	515	F 10X1	∅10
C80514ABE	375	F 10X1	∅10
C80515ABE	515	F 10X1	∅10
C80516ABE	375	F 10X1	∅10
C80521ABE	433	F 10X1	∅10
C80524ABE	490	F 10X1	∅10
C80650ABE	410	F 10X1	∅10
C80651ABE	452	F 10X1	∅10
C80655ABE	455	F 10X1	∅10
C80657ABE	535	F 10X1	∅10
C80658ABE	435	F 10X1	∅10
C80661ABE	280	F 10X1	∅10
C80711ABE	470	F 10X1	∅10

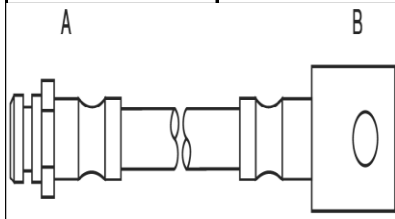

ABE	długość mm	końcówka A	końcówka B
C81531ABE	415	F 10X1	F 10X1
C81532ABE	390	F 10X1	F 10X1
C81546ABE	465	F 10X1	F 10X1
C81569ABE	345	F 10X1	F 10X1

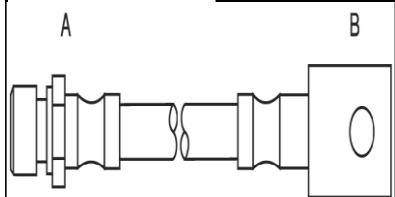

ABE	długość mm	końcówka A	końcówka B
C81533ABE	300	F 10X1	F 10X1
C81535ABE	390	F 10X1	F 10X1



72

73

74

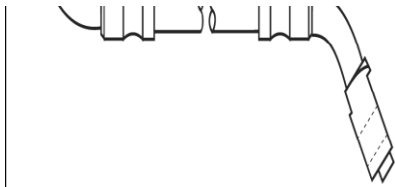

ABE	długość mm	końcówka A	końcówka B
C81534ABE	333	F 10X1	ø10
C83149ABE	333	F 10X1	ø10
C83160ABE	335	F 10X1	ø10

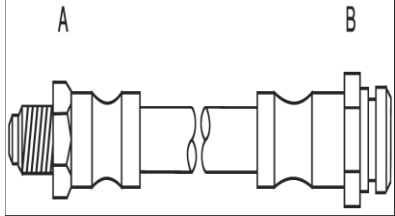

ABE	długość mm	końcówka A	końcówka B
C81526ABE	420	M 10X1	F 10X1
C81554ABE	240	M 10X1	F 10X1
C81555ABE	370	M 10X1	F 10X1
C81556ABE	325	M 10X1	F 10X1
C81560ABE	340	M 10X1	F 10X1
C81561ABE	320	M 10X1	F 10X1
C81562ABE	300	M 10X1	F 10X1
C81563ABE	280	M 10X1	F 10X1
C81564ABE	250	M 10X1	F 10X1
C81565ABE	365	M 10X1	F 10X1
C81566ABE	165	M 10X1	F 10X1
C81567ABE	395	M 10X1	F 10X1
C81575ABE	450	M 10X1	F 10X1
C81578ABE	291	M 10X1	F 10X1
C81579ABE	560	M 10X1	F 10X1
C81591ABE	410	M 10X1	F 10X1

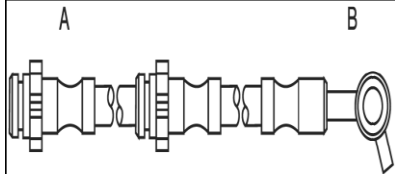

ABE	długość mm	końcówka A	końcówka B
C81528ABE	435	F 10X1	ø10
C81570ABE	245	F 10X1	ø10

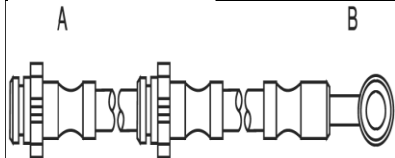

ABE	długość mm	końcówka A	końcówka B
C80653ABE	550	F 10X1	ø10
C81529ABE	460	F 10X1	ø10
C81531ABE	455	F 10X1	ø10
C81568ABE	530	F 10X1	ø10



75

76

77

78



ABE	długość mm	końcówka A	końcówka B
C81530ABE	458	F 10X1	ø10

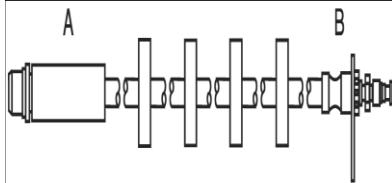

79

ABE	długość mm	końcówka A	końcówka B
C85127ABE	577	F 10X1	M 10X1
C85128ABE	577	F 10X1	M 10X1
C85134ABE	490	F 10X1	M 10X1
C86150ABE	490	F 10X1	M 10X1

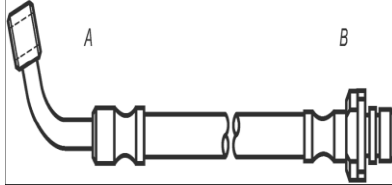

80

ABE	długość mm	końcówka A	końcówka B
C80158ABE	268	ø10	F 10X1
C80159ABE	268	ø10	F 10X1
C80161ABE	265	ø10	F 10X1

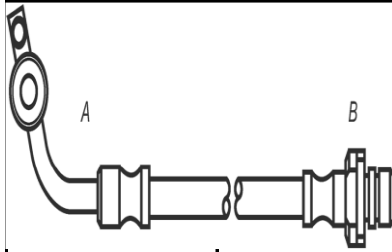

81

ABE	długość mm	końcówka A	końcówka B
C80160ABE	415	ø10	F 10X1

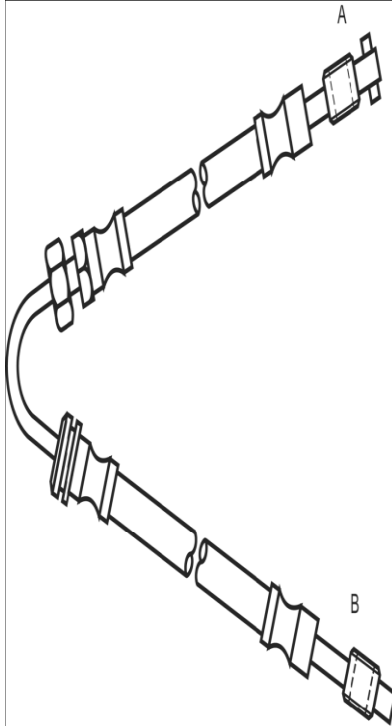

82

ABE	długość mm	końcówka A	końcówka B
-----	------------	------------	------------

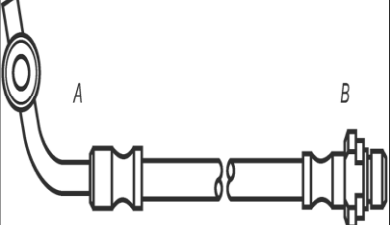
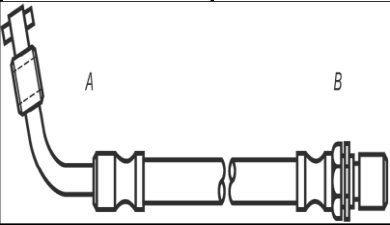
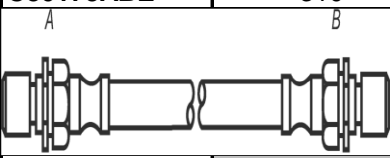
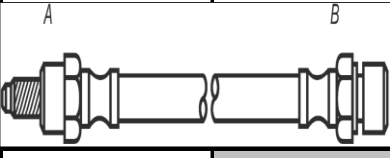
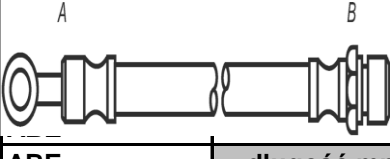
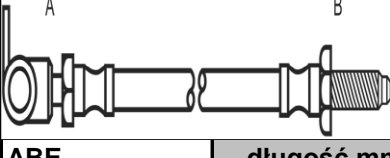
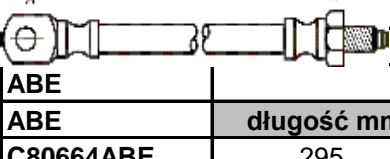
C80162ABE	245+281	ø10	ø10
			
ABE			
ABE	długość mm	końcówka A	końcówka B
C80164ABE	305	ø10	F 10X1
C80165ABE	305	ø10	F 10X1
C82036ABE	325	ø10	F 10X1
C82037ABE	270	ø10	F 10X1
			
ABE			
ABE	długość mm	końcówka A	końcówka B
C80171ABE	300	ø10	F 10X1
C80172ABE	300	ø10	F 10X1
C80173ABE	310	ø10	F 10X1
			
ABE			
ABE	długość mm	końcówka A	końcówka B
C80174ABE	470	F 10X1	F 10X1
			
ABE			
ABE	długość mm	końcówka A	końcówka B
C80175ABE	295	M 10X1	F 10X1
			
ABE			
ABE	długość mm	końcówka A	końcówka B
C80311ABE	175	ø10	F 10X1
			
ABE			
ABE	długość mm	końcówka A	końcówka B
C81700ABE	415	M 10X1	M 10x1
			
ABE			
ABE	długość mm	końcówka A	końcówka B
C80664ABE	295	ø10	M 10X1
C81944ABE	392	ø12	M 10X1,25

83

84

85

86



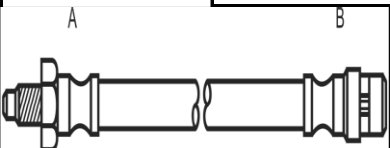
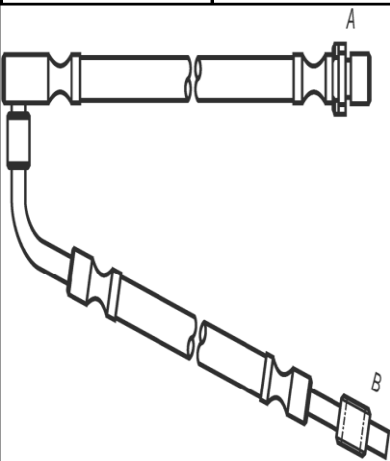
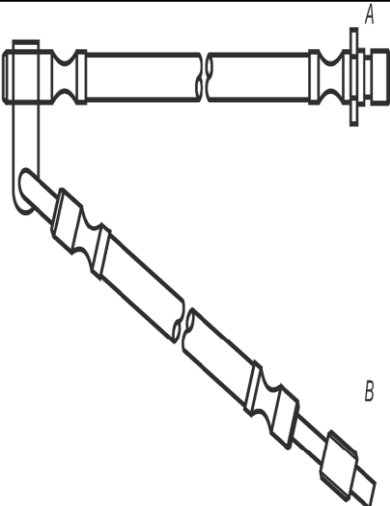
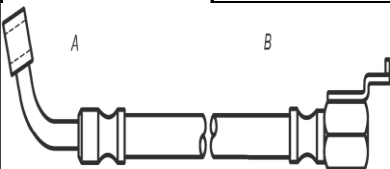
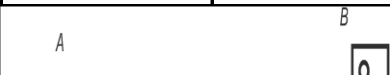

87

88

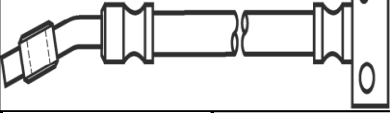
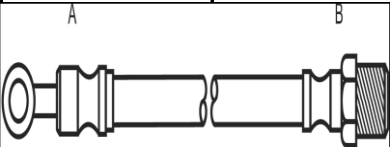
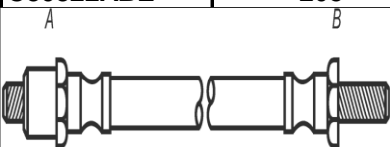
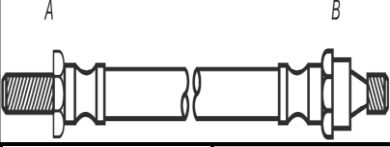
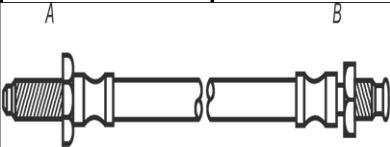
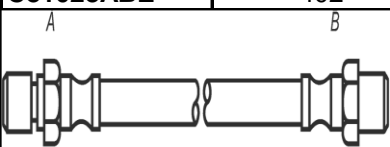
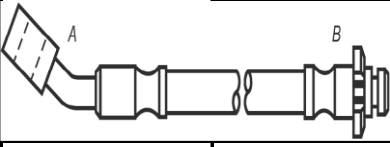
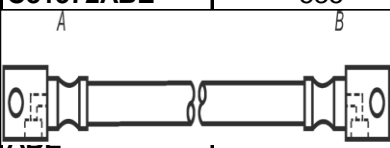
89

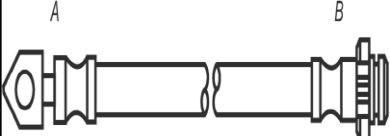

				90
ABE	długość mm	końcówka A	końcówka B	
C80666ABE	280	M 16X1,5 + F 10X1	M 16X1,5 + F 10X1	
				91
ABE	długość mm	końcówka A	końcówka B	
C80803ABE	560	M 10X1	F 10X1	
				92
ABE	długość mm	końcówka A	końcówka B	
C80813ABE	270+193	F 10X1	ø10	
				93
ABE	długość mm	końcówka A	końcówka B	
C80814ABE	270+193	F 10X1	ø10	
				94
ABE	długość mm	końcówka A	końcówka B	
C81910ABE	410	ø9,6	F 3/8X24	
C81911ABE	410	ø9,6	F 3/8X24	
				95

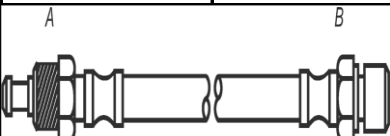
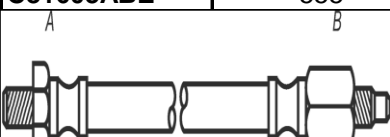
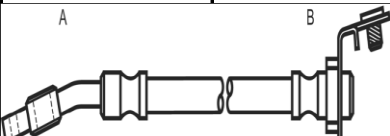
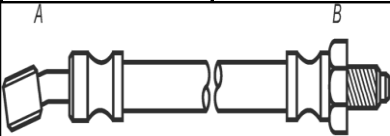

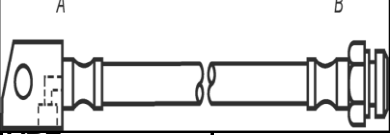
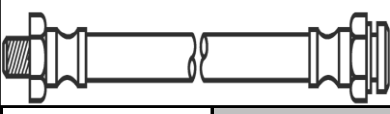
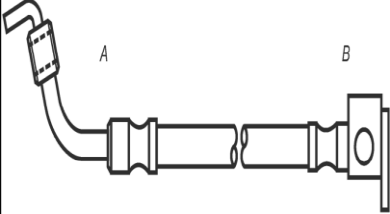
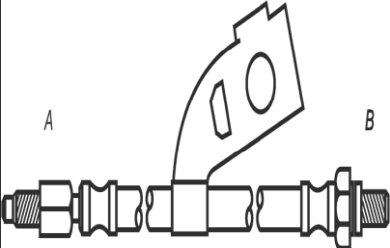
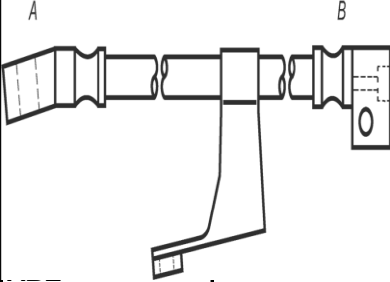
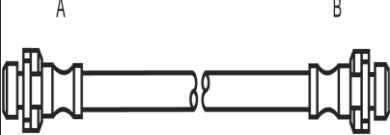
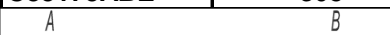
				
ABE	długość mm	końcówka A	końcówka B	
C80819ABE	380	ø10	F 10X1	
				96
ABE	długość mm	końcówka A	końcówka B	
C80822ABE	205	ø11	M 5/8 26 + F3/8 24	
				97
ABE	długość mm	końcówka A	końcówka B	
C80850ABE	220	M 3/8 24	M 3/8 24	
C81708ABE	465	M 10X1	M 10X1	
C81808ABE	385	M 3/8 24	M 10X1	
				98
ABE	długość mm	końcówka A	końcówka B	
C81024ABE	393	M 3/8 24	M 3/8 24	
				99
ABE	długość mm	końcówka A	końcówka B	
C81028ABE	402	M 12X1	M 12X1	
				100
ABE	długość mm	końcówka A	końcówka B	
C81054ABE	398	F 10X1	F 10X1	
C81154ABE	310	F 10X1	F 10X1	
C81159ABE	398	F 10X1	F 10X1	
C83163ABE	398	F 10X1	F 10X1	
				101
ABE	długość mm	końcówka A	końcówka B	
C81572ABE	535	ø10	F 10X1	
				102
ABE	długość mm	końcówka A	końcówka B	
C81574ABE	290	F 10X1	F 10X1	
C81583ABE	432	F 10X1	F 10X1	

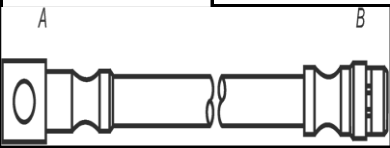
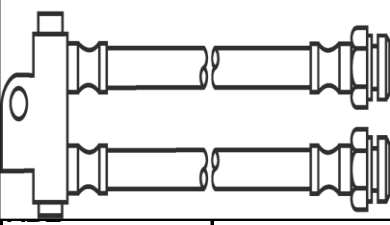
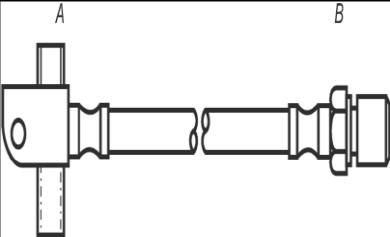
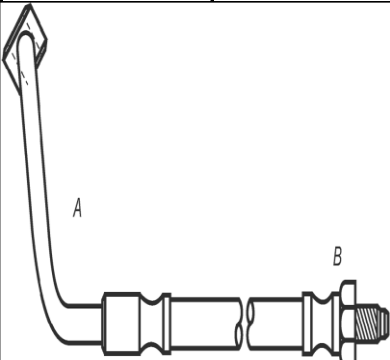
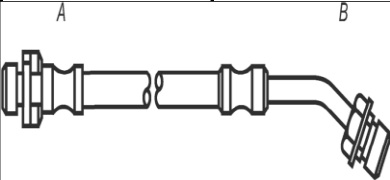
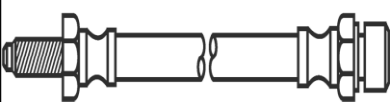

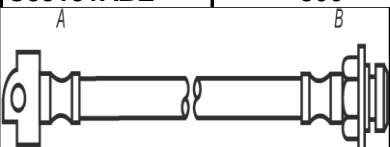
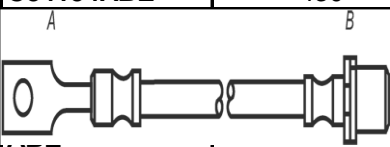
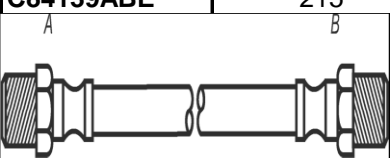
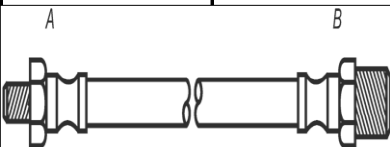
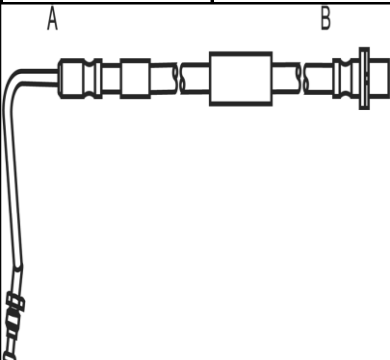
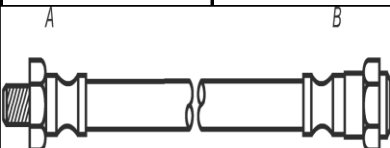
				103
ABE	długość mm	końcówka A	końcówka B	
C81576ABE	362	ø10	F 10X1	
				104
ABE	długość mm	końcówka A	końcówka B	
C81577ABE	399	ø10	F 10X1	
				105
ABE	długość mm	końcówka A	końcówka B	
C81584ABE	435	ø10	F 10X1	
C81585ABE	435	ø10	F 10X1	
C81586ABE	420	ø10	F 10X1	
C81587ABE	420	ø10	F 10X1	
				106
ABE	długość mm	końcówka A	końcówka B	
C81588ABE	310	F 10X1	F 10X1	
				107
ABE	długość mm	końcówka A	końcówka B	
C81603ABE	555	M 10X1	F 10X1	
				109
ABE	długość mm	końcówka A	końcówka B	
C81706ABE	545	M 10X1	M 10X1	
				110
ABE	długość mm	końcówka A	końcówka B	
C81803ABE	840	ø10	F 10X1	
C81804ABE	840	ø10	F 10X1	
				111
ABE	długość mm	końcówka A	końcówka B	
C81809ABE	460	ø10	M 10X1	

C81948ABE	332	M 16X1,5 + F 10X1	M 16X1,5 + F 10X1	119
				
ABE	długość mm	końcówka A	końcówka B	
C81972ABE	475	F 10X1	F 10X1	
C84136ABE	480	F 10X1	F 10X1	120
				
ABE	długość mm	końcówka A	końcówka B	
C82033ABE	494	M 10X1,25	F 10X1,25	
				121
ABE	długość mm	końcówka A	końcówka B	
C82035ABE	305	ø10	F 10X1	
				
ABE	długość mm	końcówka A	końcówka B	122
C82133ABE	420	M 10X1	M 10X1	
C83166ABE	420	M 10X1	M 10X1	
C83167ABE	420	M 10X1	M 10X1	
				
ABE	długość mm	końcówka A	końcówka B	
C82300ABE	580	ø11,15	F 3/8 24	123
C82301ABE	580	ø11,15	F 3/8 24	
C82302ABE	530	ø10	F 3/8 24	
				
ABE	długość mm	końcówka A	końcówka B	124
C83162ABE	220	F 10X1	F 10X1	
C83175ABE	305	F 10X1	F 10X1	
				

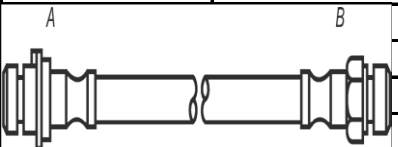
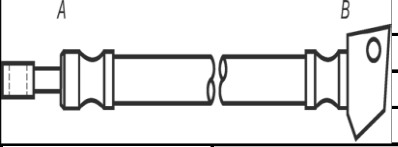
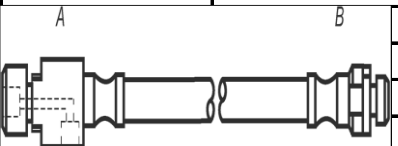
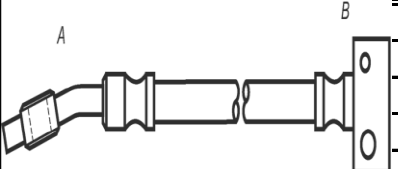
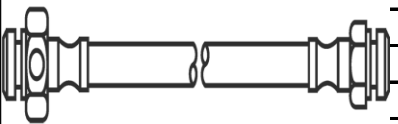
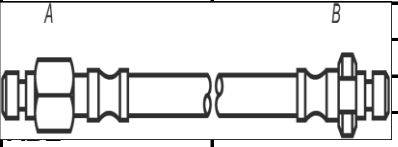
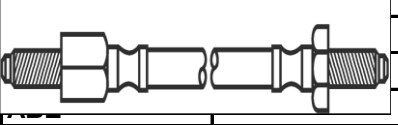
				125
ABE	długość mm	końcówka A	końcówka B	
C83168ABE	530	M 10X1	M 10X1	
C83169ABE	535	M 10X1	M 10X1	
				126
ABE	długość mm	końcówka A	końcówka B	
C83173ABE	327	ø10	F 10X1	
				127
ABE	długość mm	końcówka A	końcówka B	
C83176ABE	415	F 12X1 - F 10X1	F 10X1	
				128
ABE	długość mm	końcówka A	końcówka B	
C83177ABE	447	F 10X1	F 10X1	
				129
ABE	długość mm	końcówka A	końcówka B	
C83178ABE	404	ø10	M 10X1	
				130
ABE	długość mm	końcówka A	końcówka B	
C83179ABE	435	F 10X1	F 10X1	
				131

ABE	długość mm	końcówka A	końcówka B
C83180ABE	275	M 10X1	F 10X1
C83181ABE	300	M 10X1	F 10X1
			
132			
ABE	długość mm	końcówka A	końcówka B
C84131ABE	430	F 10X1	F 10X1
C84132ABE	430	F 10X1	F 10X1
C84134ABE	430	F 10X1	F 10X1
			
133			
ABE	długość mm	końcówka A	końcówka B
C84139ABE	215	∅10	F 10X1
			
134			
ABE	długość mm	końcówka A	końcówka B
C85137ABE	245	M 5/8 18 + F 3/8 24	M 5/8 18 + F 3/8 24
C86138ABE	310	M 14X1,5 + F 9X1,25	M 14X1,5 + F 9X1,25
C88110ABE	505	M 14X1,5 + F 8X1,25	M 14X1,5 + F 8X1,25
C88167ABE	330	M 14X1,5 + F 8X1,25	M 14X1,5 + F 8X1,25
			
135			
ABE	długość mm	końcówka A	końcówka B
C85138ABE	377	M 3/8 24	M 5/8 18 + F 3/8 24
C86139ABE	346	M 10X1	M 14X1,5+ F 10X1
			
136			
ABE	długość mm	końcówka A	końcówka B
C85139ABE	565	M 10X1	F 10X1
C85140ABE	565	M 10X1	F 10X1
			
137			
ABE	długość mm	końcówka A	końcówka B
C86137ABE	285	M 12X1	F 10X1
			

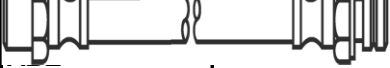
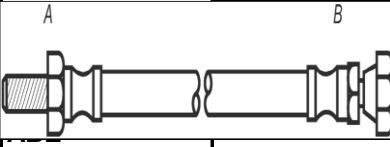
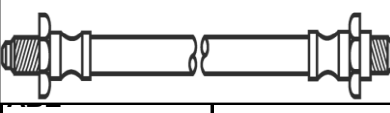
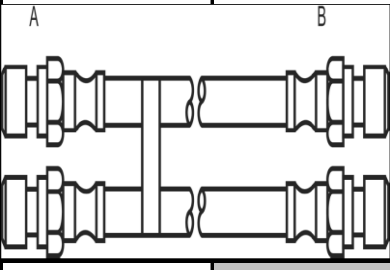
				138
ABE	długość mm	końcówka A	końcówka B	
C88168ABE	170	M 3/8 24	F 10X1,25	
				139
ABE	długość mm	końcówka A	końcówka B	
C88169ABE	277	F 10X1	F 10X1	
				140
ABE	długość mm	końcówka A	końcówka B	
C89160ABE	420	∅10	F 10X1	
C89161ABE	420	∅10	F 10X1	
				141
ABE	długość mm	końcówka A	końcówka B	
C89162ABE	268	F 10X1	F 10X1	
				142
ABE	długość mm	końcówka A	końcówka B	
C89164ABE	380	∅10	F 10X1	
				143
ABE	długość mm	końcówka A	końcówka B	
C89167ABE	410	F 10X1	F 10X1	
				144
ABE	długość mm	końcówka A	końcówka B	
C89168ABE	250	F 10X1	F 10X1	
				145
ABE	długość mm	końcówka A	końcówka B	
C89169ABE	470	M 10X1	M 10X1	
C81816ABE	470	M 10X1	M 10X1	
				146

			
ABE	długość mm	końcówka A	końcówka B
C81307ABE	278	F 10X1	F 10X1
			
ABE	długość mm	końcówka A	końcówka B
C83182ABE	600	M 12X1	F 12X1
			
ABE	długość mm	końcówka A	końcówka B
C81933ABE	495	M 10X1	M 10X1
C81936ABE	465	M 10X1	M 10X1
C81937ABE	535	M 10X1	M 10X1
C81707ABE	465	M 10X1	M 10X1
			
ABE	długość mm	końcówka A	końcówka B
C88170ABE	360	F 10X1	F 10X1
			
ABE	długość mm	końcówka A	końcówka B
C81934ABE	840	M 10X1,25	M 20X1,5+F 14X1,5
C81938ABE	605	M 10X1,25	M 20X1,5+F 14X1,5

147

148

149

150